

CONTACT

THE PHOENIX PROJECT

"YE SHALL KNOW THE TRUTH AND THE TRUTH SHALL MAKE YOU MAD!"

VOLUME 2, NUMBER 5

NEWS REVIEW

\$ 2

VOLUME 2, NUMBER 6
AUGUST 3, 1993

World's Largest Treasure Hunt

8/2/93 #1 HATONN

WORLD CURRENCY DESTRUCTION IN PREPARATION FOR—

Consider this writing an "Editorial", please. I rarely do this, but you have an opportunity to MAKE SUCH A DIFFERENCE THAT WE ARE PULLING IN ALL TROOPS! In an attempt to disallow my own staff from knowing "names", "places" and other information dangerous to them—I ask that you honor my statement that it is wise to do it THIS WAY. As we move along I ask that you relate EVERYTHING to things given prior to this—BUT do not entangle "operations" with others which may or may not be the same in different wrapping. The POINT is to get funds RELEASED and not quibble over who holds what or who did what other than as confirmation that what we tell you is true.

SO, WHAT'S IN FOR YOU AND FOR US?

Well, number one, it will continue to "blow the minds" of some of you readers who still can't believe there is both CONSPIRACY and CRIMINAL activities going on and having gone on, by your top administration. At this time, we are not in a mode of "cleaning up" anything—only getting that which was legally earned by people believing themselves to be serving their nation and fellow-citizens. Am I stupid enough to believe all was done in honest hope of Godly transactions and salvation of a dying Constitution? Perish the thought before it forms—of course not. It was begun and finished with full intent to MAKE LOTS OF MONEY! However, GOD is an interesting being—who can turn water into beautiful wine—if HIS people want the grape

juice badly enough and with right intent to salvage the GOOD from the traps of the evil intenders. Will "I" help the "cause"?—I already have
(Please see TREASURE HUNT, page 45)

HATONN'S NOTE

FOOLED US TOO!

Our Crew is "sort-of" smiling at the way things work out. With things breaking so quickly on so many fronts, we couldn't lapse a paper—for a couple of reasons. The first being that information MUST get to you readers and secondly, the paper following would be too unwieldy to handle.

We did get Rick and Princeton off on a short respite and insist that Dr. Young take a few days to attend other badly needed things. The rest of us will get the paper out and you, as readers, will please bear with us if explanations and continuity are missing in some areas.

FIRST CLASS MAIL

INSIDE THIS ISSUE

- Walter Russell Challenges Scientists, p.2
- Raping Of Private Property, p.9
- Earthquake: Planned Big One Stalled Temporarily, p.17.
- Committee of 300, p.26.
- Lindbergh Kidnapping Tied To Schwarzkopf, p.31.
- The ADL And The "Iron Curtain Over America", p.32.
- How Can I Help? p.35.
- Help Demjanjuk NOW, p.36
- Patriots: It's Time To Think, p.36.
- Lessons In Discernment, p.39.
- The Banks And The CIA Cash & Carry, p.40.

Walter Russell Challenges Scientists--He Shakes Their Foundations

Editor's note: This is a continuation of an article published in last week's CONTACT Vol. 2, #5.

We honor Dr. Jackson for his stand against the closed minds of his colleagues. If this world is going to be salvaged we need many more who will open their minds to Truth, NOW.

7/26/93 #2 HATONN

Continuation: Articles regarding Walter Russell, from the *NEW YORK TIMES*.

EINSTEIN SEEMS TO SAY THAT THE UNALTERABLE CAN BE ALTERED

QUOTING:

August 10, 1930

THEREFORE, ONE HOLDS, VIEWS OF BOTH DR. JACKSON AND MR. RUSSELL ARE BORNE OUT.

To the Editor of the New York Times:

The letters of Dr. John E. Jackson and Walter Russell in *The Times* of Aug. 3 contain, respectively, "For nearly 300 years no one, not even a scientist, has had the temerity to question Newton's laws of gravitation," and "science needs the imagination of an artist or poet to synthesize her heterogeneous complexities ..." both of which statements seem to be representative of academic static and dynamic thought, for the contributions of science to art and art to science are relative with respect to the analysis and synthesis of primitive symbolism.

The questioning of Newton's laws and Kepler's extensions is a timely and healthy inquiry directed at contemporary cosmogenetics. The assimilation of knowledge within an individual experience, therefore, can be regarded rightly as either static or dynamic, can be applied as a simple correlation of established facts, or can be accepted as a means for concentrating on and contributing to progressive thought.

In the latter instance it is clear that a metaphysical perspective upon the collective result of recent scientific research is causing many to refer to earlier basic laws. For the most part this reversion seems to extend as far as Newton and from thence is carried forward again in general, through Faraday and Maxwell, Eddington, Compton, Heisenberg and Einstein. The net result permits a repostulation of the laws of gravitation linked with the electromagnetic theory and tied to the cosmic continuum by means of a conception or reconception of time, space and matter.

THE ARTISTIC "CENTRE"

In supporting Mr. Russell's request for fair treatment, it may be added that the abstractions of science, along with the reality of art, present a fundamental intellectual and physical process to which the effort and production of the individual is irrevocably linked. The binder is found in the symbolism of primitive form. Just as the mathematician frees his mind from the concrete by conceiving modern zero to be infinity, and from it working out or back to his problem by means of symbolic devices in common usage within his field, so the metaphysician accepts the assumption of a point as the centre for induction and the scientist regards it as the beginning for all deduction and correlation.

If the laws of gravitation be considered as contributory rather than final, and if the electro-magnetic theory of a "field" be accepted as local rather than inferential, then it is evident that the Russell genero-radiative concept of foci postulates an inert but not a natural centre—the "centre" used by the artist, poet, philosopher and scientist alike as a point for departure for all creative work. This "centre," however, seems to serve an additional purpose, for it defines and subordinates the orbit of Newton and the ellipses of Kepler—both of which are in elaboration of the Cartesian and Pythagorean theorems and

axioms of coordinates.

MUST ASSUME FOCI

But in assuming the existence of "centres" (foci) as purely scientific abstractions within the cosmic structure (the recognition of the actuality of coordinate systems of reference in relation to infinite solar and planetary systems), we are able to differentiate within our mind the idea of force, acceleration, rotation and speed (time and distance), and to minimize the zero of the mathematician along with the esthetic and spiritual significance of the circle. The hypothesis then possible to establish provides a mental perspective on the metrics and geometrics of both physical and cosmic space, and we find that Newton's laws contribute rather than define, and space itself resolves and evolves into a measurable unit in terms of physical content and direction. It remains to articulate and delineate our current knowledge from an inert point, which we can place into abstract, real or natural movement within our particular field as a true centre—the pure symbolism of which is evident because of the simplicity of the concept. If we do just that, and no more, we find that we must introduce the basic elements that form our individual opinion or experience with the laws of centripetal and centrifugal force. The application of these elements in logical or structural sequence (elements drawn from the contemporary research field of pure and applied science) provides a simple "tool" for effecting abstract, physical and social deduction so that we can bring any inert point into continuous movement, the direction of which is horizontal or vertical, with respect to the laws of gravitation, and the delineation of which forms a true and natural centre.

NEWTON'S LAWS QUESTIONED

To aid and abet an escape from academic finality by means of such generalities is admittedly the essence of temerity, but Newton's laws have been repeatedly, consistently and

profitably questioned. They are rightly finite in analysis so why not let them provide for the infinite in synthesis?

In *The Times* of June 29 the pioneer achievement of Frank Lloyd Wright in the field of architectural form, design and the adaptation of materials, was outlined in a comprehensive article illustrating not only the functional relation of the engineer, the architect and the draftsman within the creative accomplishments of an individual, but also including contributions to modern architectural practice which may be attributed almost entirely to an understanding of Newton's dynamics. The catalogue of the Harvard Society for Contemporary Art states that Buckminster Fuller's dymaxion house is "the first complete attempt in architectural design to acquire a symbolism of the fourth dimension as the designing method is literally from the 'inside out' on a radionic, time space and quantum basis." Mr. Fuller's approach to his problem is through spherical geometry and the application of simple dynamics to the evolution and introduction of new materials in the logical relation to height, bulk and weight requirements.

"Roadtown" of Edgar Chambless, a practical conception of continuous structure within which is integrated all ways of communication, and the utilities of service, along with the balanced social system, constitutes a recognized application of the laws of centripetal and centrifugal social force (the centralization and decentralization of population) and is based upon social dynamics.

My adaptation of historical and chronological time (the "inverted" or "coreless" pie-chart outlined in a letter to *The Times* of June 29 last) delivers a "linear scale," the simple graphics of which postulate the inert foci of Mr. Russell and give natural movement and direction to real and abstract deduction, the dynamics of which is based upon the articulation of multiple correlations carried along at one time in logical, integrated and continuous sequence.

Recent correspondence from Geneva published in *The Times* leads us to believe that Dr. Einstein has the temerity to extend the pure symbolism of his mathematical abstractions to include a world application to child education—an indication which seems to bear out the viewpoint of Dr. Jackson and Mr. Russell that the future is behind us, is common property, and any one, even a scientist, is privileged to alter the unalterable.

G.P. HERSEY,
Ridgefield, Conn., Aug. 6, 1930

END OF QUOTING

Now, readers, I would think that the last paragraph above represents the intent of "public property" of these GREAT ideas as

well as almost any statement found thus far. These men, ALL, recognized they gained knowledge from a source somehow and somewhere "higher" than the presenting "self" AND this projects that these higher bits of information are for mankind—NOT TO HIDE BENEATH A BUSHEL IN SECRET PLACES GARNERED BY ONLY SELECT GROUPS OF ELITE OR FANCIED SELF-APPOINTED "KEEPERS". PLEASE RECOGNIZE THAT IN HIS DAY G.P. HERSEY WAS PERHAPS FAR BETTER RECOGNIZED THAN EITHER RUSSELL OR JACKSON.

Next comes a repeat of one we have already offered but I ask that Dharma retype it for I want it in her head, please. In the first offering we had "deleted lines" which were actually present but the one who did the copy work had carefully explained and marked the papers and Dharma just didn't see it in time to get the missing parts into that writing. It is important enough to repeat it with the insertions. Please be patient for by the time we did that prior writing, Dharma had been at the keyboard over seven hours at start and the brain and the fingers get awash.

Further, I had a VERY GOOD REASON for allowing the printing of the information EXACTLY as copied, **with the lines missing, BECAUSE I WANT YOU TO NOTICE VERY CAREFULLY—THAT UNLESS YOU HAVE THE WHOLE THING—YOU CAN NOT KNOW OF THAT WHICH YOU SPEAK OR HAVE OPINION! YOU MUST HAVE ALL OF THE MISSING INFORMATION TO FORM VALID CONCLUSIONS ABOUT ANYTHING. YOU SCIENTIFIC MINDS WOULD HAVE ALREADY HAD YOUR IMPATIENCE WITH ME FOR PRESENTING ONLY THE MAJOR PORTION OF THE ARTICLE AND THAT, DEAR ONES, IS THE HALF-TRUTH AT BEST, THAT HAS COME TO BE IN YOUR INFORMATION DISTRIBUTION SERVICES.**

MR. RUSSELL FINDS SCIENTISTS TOO READY TO ACCEPT THEORY

QUOTING:

His Attempt at Reformation Not Based on Metaphysics, He Declares.

The New York Times, Aug. 17, 1930.

To the Editor of The New York Times:

Since the publication in the *TIMES* of my statement that modern science is without a foundation and needs a major surgical operation to put it in line for a logical cosmogenetic synthesis, I have been bombarded by telephone and by letters questioning this statement and others made in my book *The Russell Genero-Radiative Concept*, recently published.

May I tell those people who think I have a superficial, metaphysical concept which I am trying to inject into practical science for its reformation that I am as thoroughly

prepared to carry out my program with dynamic answers, not metaphysical ones, as Copernicus was when he upset an equally obstinate world of thoroughly satisfied Ptolemyites? Also I am as thoroughly aware of the difficulties of uprooting established ideas as he was.

I am also thoroughly conversant not only with every experiment that has given science its present unstable state, but also with the wrongful deductions which have resulted from those experiments.

KNOWS SCIENTISTS' THEORIES

I am as familiar with the experiments and observations of Newton and Kepler as I am of those of Faraday, Cavendish, Rutherford, Bohr or Millikan, and I also am as familiar with the things which these great men did not see in their own experiments as those which they did see, and even then misinterpreted.

An observation of an effect of Nature is equal to an experiment and a proper deduction from either is more important than either.

Newton, for example, would have solved the other half of the gravitational problem if he had found out how that apple **and the tree upon which it grew got up in the air before the apple fell.**

I challenge the world of science to correctly and completely answer that question. Let your readers qualify for the right to subject me to their criticism as an impractical visionary by first giving a dynamic answer to this by no means simple question.

Therefore I say to all my critics who wonder why I do not go into the laboratory and "perform experiments" that I do perform experiments in physical laboratories and make profound observations in Nature's vast laboratory that have fitted me to make new and logical deductions from old experiments which have no inconsistencies and no exceptions.

EFFECTS OF MOTION ILLUSIONS

To illustrate: Suppose a man experimented with the moon running behind the trees as he ran, then set down his conclusions from the "facts", as he saw them, such as the correspondence of acceleration and deceleration to his speed, we could easily point out the error of such a deduction because we are familiar with the illusions of perspective.

Science has never considered the fact that in the universe of motion all effects of motion are illusions. Illusions are not limited to perspective but to every electrical, chemical and astronomical relation.

Nature is the supreme deceiver, the champion "poker bluffer", who, with a

simple hand, makes you think she has much.

Nature is simple. She has but one force (which she divides into two), one form (which she divides into many), and seven patterns (which she complexes by repeating them in such marvelous systems of wave periodicities that it needs imagination, rather than eyesight, to coordinate them).

Nature can be beautifully described by that child's toy of hexagonal mirrors which makes the most exquisite and complex patterns in color and form out of a bit of feather, some chips of colored glass, a toothpick and other odds and ends.

Every one knows how those simple things are not only complexed but glorified by such a treatment.

NATURE'S SIMPLE PRINCIPLES

My humble contribution to science is to point out these simple principles of Nature which would, if known, have prevented one untruth to pile up on top of another until, even with the aid of experimentation, a theory which can survive five years is exceptional.

I will warrant that the dinner coat which Sir Oliver Lodge wore in New York when he delivered his lecture on energy and atomic structure is still presentable, but Sir Oliver himself would under no consideration repeat that lecture today.

The entire modern theory of atomic structure is so utterly without parallel or precedent in Nature that fantasy only mildly expresses it. It is to be regretted that the profound thinking of profound men is thus being wasted on conclusions which cannot possibly endure. **[H: It might be added that the profound thinking of those profound men are also kept from use and presentation by ones who do not understand the magnitude of the offering in point. It is most certainly a time of coming together and sharing the gifts as given so that civilization CAN ENDURE.]**

Scientists ignore Nature when they choose, or when mathematical formulae work out in accordance with preconceived premises. Scientists then become inventors and work out wonders which Nature never thought of. I can cite hundreds of such inventions born of supposedly observed facts of experiment.

LA PLACE'S MISTAKES

Mathematics are useless if the premises they start with are wrong. La Place, the greatest mathematician of his day, "proved" many things which have since been disproved. He even went so far as to prove that the outer edges of his rings moved faster than their inner surfaces,

and his contemporaries accepted that impossibility as Niels Bohr's "jumping electron" was accepted by his contemporaries.

Nature hasn't one separate series of laws for big mass and another series for small mass. She has one law for both, but science unhesitatingly invents a series of laws for little mass that outdoes the reliance of the Arthurian sages upon a credulous public.

The moons of Jupiter and the planets of the sun pursue their courses around their primaries in an orderly periodic fashion in strict obedience to the two forces which command and control them from two foci.

It would be the most astounding claim imaginable to state that this earth could suddenly jump to the orbit of Mars without consuming one-millionth of a second of time, yet that invention is the utterly fantastic and completely unfounded belief of modern science regarding the planets of the atom.

I could write volumes based upon modern electrical experimental data to prove that such a happening is **not in Nature's scheme.**

Science attributes this deduction to a "brilliant young Dane, Niels Bohr", who, working under Rutherford, proved it by experiment, backed by Rydberg's constant, Coulomb's law, mathematics and the evidence of the spectroscope.

Of what use is Bohr's mathematical equation regarding the hydrogen spectrum, for example, if the four admittedly assumed premises upon which it is based are not in accord with Nature's plan of motion?

WRONG BASIC CONCLUSIONS

Of what value also is the spectroscopic evidence if the presumption that band-spectra are caused by molecules and line spectra by atoms is found to be a wrong one? In respect to this I am prepared to offer consistent reasons why band and line spectra have another and more logical cause.

I can cite wrong premise after wrong premise which has caused science to form wrong basic conclusions, such as that there are separate negative and positive charges instead of doubly charged masses, also that positive and negative "charges" attract each other when the evidence in its favor is the simplest of Nature's illusions and there is an overwhelming amount of evidence against such a law. Take only one for example: How does science explain the fact that in all decomposing compounds like charges seek like charges and repel all others? If this law were true the universe which we know could not hold itself together, for all similar substances and atoms of substances would be explosive, and a pound

of any one substance would be impossible.

WALTER RUSSELL
New York, Aug. 12, 1930

SCIENTISTS SHOULD EXPLAIN

The New York Times, Aug. 24, 1930.
Written: GENEVA VIOLA WOLCOTT,
New York, Aug. 18, 1930.

To the Editor of the New York Times:
Owing to the fact that the world and his wife are becoming astro-minded, the letter from Walter Russell that appeared in the Aug. 17 issue of the *Times* impels me to air my views despite the fact that the press's attitude is decidedly against the "female of the species" going scientific.

Mr. Russell's arraignment of scientists who work by rod and plumbline, so to speak, and in many instance reckon without their host—Nature—stresses a striking example: From era to era scientists have explained the orbital ellipse, postulating the fact that in the solar system (by way of concrete example) the sun (Sol) forms one of the two foci of an ellipse, let us say, of the orbit of Earth. This, as every schoolboy knows, is inevitable.

Granted, but no one seems to have given a thought to the other focus. Kepler devised the radius vector in order to provide for the sweep over equal areas in equal time as Earth performed its trajectory from perihelion to aphelion, then on again to perihelion. This device has been demonstrated by means of delineation, oral and written description until every student knows it as he knows his alphabet. So far, so good; but what of the other focus without which no ellipse is possible?

Now along comes Mr. Russell to demonstrate, first of all, a forcible axiom that appeared recently in the *Times*: "The only thing stronger than armies is an idea whose time has come."

Accounting for the other focus demonstrates Mr. Russell's idea (concept, rather) that the twin focus is a vacuous force functioning just as effectually as its mate, the sun. Thanks to everyday utilities, this function is within the grasp of the lay mind. Now, if the professionals decline to accept this view, why should they "hold out on us", to drop into the vernacular, by failing to account for the second focus without which no ellipse is complete? **[H: This is the same question I raise when disallowed from utilizing, with full recognition, Dr. Russell's work in the PLEIADES CONNECTION series of JOURNALS. Why do these people wish to keep this information under singular lock and key? We have no wish nor intent to validate nor pull down the thrust of such as US&P—**

but in checking most carefully in full detail, we found that even though some copyrights may well have been ASSUMED shifted off to said "University"—the proper corporate records do not present such. The line of appropriate paperwork would have to explicitly shift each and every title and manuscript in every detail. They do not! Further, if the material is such that it is "joint" but only one facet of information is utilized—it is "literally" not in question if another UTILIZES THE MATERIAL ISSUED AS FACT TO FURTHER FACT OR DRAW OPPOSING CONCLUSIONS. We who offered the CONNECTIONS series only wished honor and attention in a most wondrous way—to Walter Russell. We do not share the same appraisal of the work of Lao nor to her intentions or actions. Lao was an avowed humanist and although her so-called metaphysical conceptions were "new age" and even "spiritual" on the surface of it—she was humanistic in every recognized aspect.]

Surely they are not afraid of losing their laurels! Perish the thought! If so, they differ from the sportsmen who are always scouting about to enlist amateurs into the professional ranks. Let us hear from the acknowledged scientists why the second focus has been ignored; also if there is any law in celestial mechanics against adopting new discoveries—inventions, if you will.
GENEVA VIOLA WOLCOTT

END OF QUOTING

These articles bring forth a lot of information and a lot of questions, don't they? From "why not recognize women's input" to "wise reasoning" is visible from the above article—from, by the way, a very prominent personage of the day!

I think I shall ask for a break here so that we have the approximate amount of material for the next chapter without interrupting it.

I hope you are finding the information interesting and thought provoking for I find the puzzle fascinating—most especially since you find yourselves in something similar to a confrontation on the magnitude of a "Darwin" Scopes trial. The great difference here is that no "trial" IS EVEN ALLOWED AND THE WRITER, DHARMA, IS CONVICTED, CHARGED AND PENALTIES IMPOSED FOR NOT ONLY WRITING—BUT FOR CONTEMPT OF COURT BY SIMPLY BEING ALIVE. YES, INDEED, INTERESTING!

7/27/93 #1 HATONN

Continuation: *The New York Times* articles regarding Walter Russell:

SHAKING SCIENCE'S FOUNDATIONS

QUOTING:

August 31, 1930

To the Editor of The New York Times:

Several of my contemporaries in the electrical field seem to be particularly incensed because of a statement made by Walter Russell in *The Times* that "all modern theories of atomic structure have no more relation to nature than green cheese."

Their rancor is based upon the fact that great scientists such as Millikan, Bohr, Rutherford, Langmuir and others of great prominence have proved their theories by experiment, and Russell, who seems to have obtained most of his knowledge by close observation of nature rather than in the laboratory, tells these men that their conclusions are wrong because their fundamental premises are wrong.

Personally I find it hard to accept Bohr's "jumping electron", as Russell calls it, and I find many others equally skeptical. John Langdon Davies in his recent book, *Man and His Universe*, criticized this belief severely, ending as follows: "Now, if scientists seem to believe these two things are true, it means that the universe is essentially meaningless."

Russell claims that all conclusions of scientists in regard to things electric are based upon the assumption that all masses are "charged" either positively or negatively. This, he says, is fundamentally wrong, for all masses are doubly charged, each one being preponderantly one or the other just as male and female are known to be so.

Russell has set up such a very strong and convincing argument in support of his claim that my traditional electrical training is severely shaken even if I am not a 100 percent convert as yet.

If, however, Russell succeeds in establishing this one claim alone he will have shaken the very foundations of science, for every textbook on electrical practice, physics and astronomy will have to be rewritten and another mass of mathematical formulae will have to be relegated to the waste basket to keep company with much that has gone that way before.

GEORGE SOULE

New York, Aug. 27, 1930

MR. RUSSELL UPHOLDS THEORY OF A "TWO-WAY" UNIVERSE

**Proton Is Not a "Hole", He Declares,
Merely Because It Acts Like One.**

November 2, 1930

To the Editor of The New York Times:

The Times editorial "This Month's Atom" has so filled these intervening days with answering questions as to whether Dr. Dirac's theory was in line with my cosmogony that I am constrained to answer it. Also, I might as well include the question so often asked regarding the comparative relationship of Dr. Robert Andrews Millikan's statement published some time ago, also in the *The Times*, for both are interrelated.

The editorial says that "when an electron disappears the vacancy left behaves mathematically like a proton."

A hen seeing her duckling brood taking to water could not be more surprised than modern scientists in seeing this "hole" act like a proton. The proton is not a hole, however, as Dr. Dirac concludes, just as a duckling is not a chicken because it acts like one in respect to the hen. The hole is the vacuous force which acts as an expansion pressure force exerted against an equal compression pressure force which is located in mass and culminates at its centres.

Neither is the proton a hole because it acts like one in all respects save direction, more than an inward explosion toward a vacuum is like an outward explosion because it also acts like one in all respects save direction.

A COMPLETE CYCLE OF MOTION

Modern science does not recognize the vacuous force in nature, due to the incomplete Newtonian concept which has given us a "one-way" universe instead of the "two-way" universe of my cosmogony. If Newton had completed his gravitational observations and Kepler had been as curious about unmentioned vacuous focus as he was regarding the focus he did mention, science would now understand what this newly discovered negative "hole which acts like a proton" really is and I would not be in the position of being disliked by my scientific friends for playing the part of Copernicus to their Ptolemy.

The following is a brief explanation of the complete cycle of motion which will explain what Dirac found, what he has not yet found and what he and Lodge and others say they do not understand regarding that which he has found.

The electron is a doubly charged mass. The action of integrating any mass is a generative or condensive one which is called the attraction of gravitation. This causes mass to appear around a common centre of high compression pressure and gives rise to the commonly believed error that matter attracts matter, which is not true to nature. The reaction to this action of compression is the expansion of the field which has been rendered vacuous by thus being drawn upon by the gravitative, indrawing,

endothermic action of condensation. The expansion of the residual volume, or field surrounding the mass, is a vacuity which is as equally minus the original equilibrium of the total volume as the centre of the mass is plus that equilibrium.

SOURCE OF AN ERROR

The force represented by that vacuity is an expansion pressure which is the equal and opposite of the gravitative compression pressure and gives rise to that commonly believed error of light repulsion which is not true to nature.

The "hole" that Dirac describes is the vacuous force of the expansion stroke of the universal pump. This force is correctly described as negative electricity, negative discharge, radiation, radio-activity or by any other name which results in the disappearance of mass into its surrounding tenuous field.

On the contrary, the high pressure point of dense mass is the condensive force which is the compression stroke of the universal pump. This force is correctly described as positive electricity, positive charge, gravitation, condensation or by any other name which results in the appearance of mass into solidity.

These two opposing actions and reactions constitute the electro-magnetic oscillations, or compression-expansion sequences, which are present in every mass and which constitute the mechanistic or life principle of the universe. These sequences have a periodicity of preponderances which are first preponderantly generative and then preponderantly degenerative, which we know of as the phenomena of growth.

We have now completed the cycle of appearance and disappearance of mass through the series of endothermic, in-breathing, positive oscillations of compression pressure and exothermic, outbreathing, negative oscillations of expansion pressure which is the dual characteristic of electricity; but we have one more characteristic of nature as a result of these action and reaction sequences.

This one other attribute of nature is the reproductive or regenerative force which is set up solely by the resistance of each expression of force against the other.

DUAL CHARACTER OF FORCE

This characteristic attribute of nature to repeat herself, and to do so in waves or striations of periodicities, is because of the dual character of force to express itself always in equal opposition of force.

Every effect of motion thus results in the production of the opposite effect, therefore the negative reaction which results in

the disappearance of the electron is accompanied by its equal and opposite action which causes the reappearance of the mass by the reverse action of the "hole".

Hence there can be no such thing as a positively charged mass or a negatively charged mass. All charging masses are simultaneously discharging and all discharging masses are simultaneously recharging other masses in this two-way universe of motion. Energy is kept continually moving between the high-pressure hot points of gravitative centres and the low-pressure cold areas of the evacuated fields which surround all masses.

This constant interchange is the cause of the motion of force which moves only for one purpose, and that is find an equilibrium position for which it is ever in search of and never finds, for that position is itself always in motion.

While in search of this ever-moving position the work of the universe, and of man, is performed. There is no other way that work can be performed than by the oscillations of this dually acting electric force as it surges back and forth between the two polar dead centres of force, the gravitative focus and the vacuous focus.

It matters not whether this two-way interchange of potential is between the poles of a battery, which we call electric current, or between dynamos or solenoids, which we call lines of force, or between the high and low barometric pressure position of the weather map, which we call winds, or between the sun and planets, which we call radiant energy, or between elements, which we call radio-activity—all are the same. All are seeking an ever-changing equilibrium position and kept continually on the go and producing that thing which we call energy.

Every mass in the universe is a complete pump oscillating between two equilibrium dead centres of opposed force. Every two masses are reciprocating, collaborating and coordinating their respective energies, each in accordance with its respective and comparative potential. Each mass in the universe is revolving around every other mass in elliptical orbits determined by their mutual ever-moving compression and expansion foci.

All masses, whether electrons in hot suns or electrons in cold space, are simultaneously integrating by their generative oscillation, and disintegrative by their opposed radiative one. This is the completed cycle of the motion of force toward which Dirac has made a step in the right direction.

[H: Here again, Russell has detailed his approach and his subject to exacting presentation to ALL READERS. This would appear to me to be intent toward having mankind have access without restraint—to his scientific application

to the wave-universe in a LIGHT UNIVERSE. This certainly would not, by its mere presence in the largest newspaper of the day by Russell, personally, indicate a great desire for his work to be FULLY AND TOTALLY PUBLIC DOMAIN. I have no intention to further complicate my scribe's life by continuing to harangue with holders of information which was ONCE COMPLETELY PUBLIC DOMAIN—but neither can I understand WHY it is so difficult to share this SCIENTIFIC TRUTH OF UNIVERSAL OPERATION WITH THE VERY PEOPLE FOR WHOM IT WAS INTENDED AND ORIGINALLY GIFTED. SO BE IT—WE SHALL CERTAINLY ABIDE BY ALL FEDERAL COURT ORDERS, BUT IT ELUDES MY REASONING LOGIC!]

DR. MILLIKAN'S STATEMENTS

Robert Andrews Millikan is the only other man who, to my knowledge, has begun to divine nature's secret of the duality of force and continuity of creation in cycles. Dr. Millikan declares: "In the hot stars and the sun, matter is being disintegrated into energy or radiation; in the unimaginably cold expanse of infinite space, radiation or energy is being reintegrated into matter."

If Dr. Millikan had written that all mass, whether in hot suns or cold space, is integrating by its contractive oscillation (which is caused by the cold of its preceding expansive one) and that it is disintegrating by the heat of its preceding contractive one, he would have been right.

To say, however, that matter is disintegrating in hot masses and integrating in cold space is not in keeping with nature's method of creation, for it would not account for the integration of mass in hot suns except by miracles or by "divine ordainment", as they said in the Middle Ages, nor would it account for the disintegration of mass in cold space except by the same method.

In order for that principle to work, Dr. Millikan would have to find a critical point of temperature below which all matter integrated and above which it all disintegrated. This is impossible, for all matter has differing melting points, according to its pressures or densities, these points rising as pressures rise.

We know that above these critical points at which all elements melt the solids disintegrate into liquids, then into vapors and then into gases. But the very act of disintegrating by radiation causes a relatively cold reaction to take place which reintegrates. Both processes are therefore taking place above and below the melting point, and this is as true along the trail of a comet which is luminous and relatively hot in its contractive oscillations at 240

degrees below zero as it is true in Vega's heart which is relatively cold in its expansive oscillations at 300,000 degrees or more.

WALTER RUSSELL

New York, October 29, 1930

MR. RUSSELL MAY BE RIGHT

Dr. Jackson Withdraws Criticism of "Two-Way" Universe and Seeks Proof.

THE NEW YORK TIMES, November 9, 1930.

To the Editor of The New York Times:

Some time ago *The Times* published a letter of mine severely criticizing Walter Russell for presuming to attack the "laws" of Kepler and Newton. Obviously, as a scientist, I resented the sweeping claim of a non-scientist "that science needed a major surgical operation to put it in line for a logical, cosmogenetic synthesis". I felt that it was ridiculous for anybody to criticize such laws, and especially anybody without recognized scientific standing to attempt such surgery.

[H: Is this unlike the attack against our writers and Dharma? Without checking into possible intent or work in any manner it was immediately attacked along with my secretary, thrown into a Federal Court of Law and the entire point of either WRITER was missing all attention while running up lawyer's bills, court costs, painful disagreements which cost so much in working time (which is so little with which to begin) in integration of resources. Your PROOF of value in both instances is the adversarial scooping up of the Russell material under "re"copyright efforts and then, the attack against the OTHER source of the information desperately mandated for your society. We SHOULD NOT BE IN COMPETITION—we should be working jointly to bring necessary material substance to you, the remnant civilization. I will not, however, share, work, join or integrate WITH THE ELITE COMMITTEE OF 300 IF IT MEANS THE ABSENCE OF THE VERY WORKING SUBSTANCE AND KNOWLEDGE TO THE SOCIETY AT LARGE. I DO NOT WORK WITH GOD'S "ENEMY" AND THESE COURT PROCEEDINGS ARE ADVERSARIAL TO THAT SOURCE OF PERFECTION AND "ALL" POSSIBILITY! Together we can change the world in ALL manners—or, we can continue as adversaries and, finally, WE shall WIN! Will it be in time to save the tedious steps toward full explanation otherwise presented? Yes, I would think so for there are several with working models and all they need is a bit of encouragement and a few minor changes in perception and perspective. Dharma, it is not YOUR problem, chela, so release

the concern unto me for I shall not trample the opposition further. Neither shall I long leave the door open for understanding with important participants (if they but choose open mindedness) in that grouping. The best way to lose an enemy is to make of that one, a friend. I have no animosity or hostility and if we could move beyond the perceived anger and misperceptions of court battle—we could produce incredibly wondrous things. So be it.]

I now wish to modify my statements and criticisms, for, since writing that letter, my viewpoint has somewhat changed from scathing to one of expectation. What I considered the over-night inspiration of that revolutionary type of man we call a "crank" might be, instead, the result of an intelligent and prolonged study of Nature.

COORDINATION OF UNITS

Mr. Russell has evidently approached his solution to the great riddle from the point of view opposite to that of the scientist. He has considered the universe as a whole and offers explanations for the workings of its units as they fit into the whole, while we scientists study the separate parts but as yet cannot fit them together perfectly.

Who is to say that Russell's method of approach is not as valuable as our own, especially when it is carried on by so keen an observer? Let us give him a chance for a proof. The future will tell. I believe we should welcome such a mind, with its freedom from the traditions by which our minds are bound to the extent that we sometimes forget to question. I, for one, do not want to be "set" and invincible.

I am not yet prepared to say that I thoroughly accept Mr. Russell's "two-way" principle, but I am immensely intrigued by it, for it gives this universe of motion a meaning to me that it did not have before. In fact, our universe is rather meaningless even to ourselves; we know very little of the why of anything and many researchers have practically ceased trying to fathom it. In our experiments we see the effects but do not always find a satisfactory explanation of the cause. If it "works" we are thankful, so we do not always worry about the "why".

OPEN TO CONVICTION

Mr. Russell's theory may be the method of understanding the nature of electricity, the generation and degeneration of mass and the universal mechanistic principles, through his "two-way" swing of the universal pendulum. In this defending his principles I again repeat that I am only weighing them in my mind at present, but I think the entire scientific world should

also seriously weigh them, for, if Russell is right—and he surely thinks he is right—his claim that science needs "a major surgical operation" is justifiable.

A few outstanding and seemingly irrefutable facts stand in favor of the "two-way" principle. First of all, the compression-expansion sequence constitutes a cycle of motion which is mechanistic; it conforms with the known oscillating character of all electrical force. It makes matter comprehensible when each mass is known to be a compression-expansion "pump", or storage battery of polarized force doing the work of the universe.

Russell says that every effect of motion gives birth to its opposite effect, that our degenerative, radiant energy which is wasting away our universe becomes generative energy simply through its gravitational change of direction toward mass instead of away from it. The same radiation which degenerates our sun regenerates this planet as light. Let us give him a chance to prove that and see what the outcome is.

Our "positive" and "negative" are admittedly meaningless words. Russell's dual principle gives them a rational and reasonable meaning which may be mechanically comprehensible. He says that "positive" is plus an equilibrium of a quantum of energy, and that "negative" is minus that equilibrium. In other words, a vacuous condition is created in a given quantum of energy by pumping some of it out of one part (the surrounding field) and into the other part (the central mass). How simple it is to understand an electrical short circuit, or a chemical reaction, when thus explained, or to understand the motion of energy as force seeking an equilibrium.

I remember when we used to think that the current in a battery flowed only in one direction. We now admit its flow in both directions. If nature expresses itself universally by a flow in both directions, instead of in isolated instances, it is well to know it even though we old-timers have to adjust our practice to it.

KEPLER'S LAW NOT INFALLIBLE

I was especially vituperative toward Russell because he dared to tamper with the Kepler law. I can now see that Kepler's mention of a single focus, and his failure to mention the other, coupled with Newton's single attribute of matter to attract matter without mentioning its equally apparent power to repel, deprived science of a possible solution of the universal riddle.

The second focus of Russell's is physically and mathematically necessary to an elliptical orbit. Why did not some scientist think of this instead of waiting 300 years for an artist to tell us about it?

I am anxious to see that other focus proved as the seat of the vacuous force of

negative electricity that Russell claims for it. When his present experiments with lines of force are completed, by means of which he expects to prove his contention, and are found to substantiate his claim experimentally, we shall then know that positive electricity is that which is flowing inward, accumulatively, toward a point of compression (which is one of the dead centres of force in the universal machine) and that negative electricity is that which is flowing outward, dissipatively, toward a vacuous field (which is the other dead centre of force).

We shall then be convinced that Russell's contention that matter does not attract nor repel matter is probably true and that attraction and repression-expansion oscillations with which we have long been familiar in electrical practice, but did not connect up with gravitation or radiation.

I invite the collaboration and criticism of my fellow scientists at large to join me in this, because, should Russell be able to prove his claims, we should all give him due credit, and if he fails, it will then be time to add his theory to the long list of dreams. He is in earnest and at least deserves our support.

JOHN E. JACKSON
New York, Nov. 4, 1930

RUSSELL'S THEORY WINS APPROVAL

July 7, 1931

It Contains More Hope Than That of Sir James Jeans.

To the Editor of The New York Times:

During the past weeks people of this country who are interested in scientific and cosmic problems have been reading a good deal of the doings and sayings of Sir James Jeans. The newspapers have given much space to his theory that the universe is running down. At a scientists' dinner last week he told not only his large and distinguished audience, but thousands of radio listeners, that only a mathematician could understand the universe. His tones were lugubrious [mournful], his face sad. His message is destruction; his complicated theory withers whatever it touches.

In the Museum of Science and Industry of New York there is on exhibition a group of remarkable paintings which refute the Jeans theory and substitute a simple, constructive idea of a two-way universe. This exhibition and what it implies seems to have escaped the notice of the news-gatherers. The artist is the well-known American, Walter Russell, president of the Society of Arts and Sciences, who has been decorated by many European governments and societies. Mr. Russell's writings have

aroused considerable controversy in the columns of The New York Times. Those of his paintings now on exhibition illustrate what he calls the dual action of the one force in the universe. The force, he says, is light, and all matter is "frozen light".

The Jeans theory is pessimistic; the Russell hypothesis is full of hope and beauty. Which of these deserves the attention of forward-looking Americans, especially at this time when the world is looking for "depression proof" ideas.

LOUIS HASBROUCK
New York, June 3, 1931.

END OF QUOTING

Perhaps as you understand more about the rising recognition of Walter Russell's work and consider that which happened to Dr. Nikola Tesla at the hands of the Elite One Worlders and bankers, a lot will become clear to your perceptions. It may well become most clear as to WHY a beautiful woman would enter the picture and the focus be shifted from SCIENCE to metaphysics and the work open for the public domain—was gathered again into disallowance for freedom of USE. There had to be something done lest the Russell explanations take hold and the public demand use of same. The massive change of such

information which would wipe out entirely ALL prior concepts of almost everything believed and utilized—would wipe out business as recognized. There had to be something to hold you in the Dark Ages to prevent this massive change to happen. The adversary NEVER misses a beat on his drum, readers—NEVER!

So, what has happened? The Elite have utilized the scientific knowledge to gain control of the WORLD. YOU have been given NO INPUT OR USE OF ANY OF IT. It has gone to build the very shackles which will terrify, panic and bind you—while you drift aimlessly along never having HEARD of one, Walter Russell and not many more, Nikola Tesla. If the adversarial people and the Federal Court system has its way—the information will again be gathered up and tucked away so that YOU WILL NOT SEE WHAT WAS DONE UNTO YOU.

You can note from the timing of writings that as the scientific community began to recognize this gifted input from higher realms—the physical constraints and temptations of Walter began and was finally pulled-off in the 1940's when Walter neared his 80s. It is simply history repeating itself in negative form and the physical perceptions and needs for ego attention and fulfillment—overshadow the spiritual journey and purpose as a messenger to God's creations. It is ever thus and ever as difficult to rise beyond!

Let us close this portion, please. Thank you.

US&P Legal Attack And Holiday Greeting

7/27/93 #3 HATONN

ADVERTISING!?

As you ponder in your mind, the things which flow in ceaseless streams through consciousness—one looks at that which is supportive, destructive and obvious misrepresentation.

Not only did problems begin with the University of Science and Philosophy for the Ekkers, E.J. and Doris, for well over a year ago—the slings and arrows are ever present.

How would you feel if your very life was being drained away and the following came to you PERSONALLY from ones at US&P:

A HOLIDAY GREETING

QUOTING:

TO OUR TREASURED STUDENTS AND

FRIENDS:

1992 was a fabulous year of growth and change for the University. We had four new additional books published; we established The Crystal Blue Group whose main function is to assist in environmental rehabilitation and help create a peaceful and sustainable civilization; we started *The Fulcrum*, a Science Newsletter with its second issue containing a report on the successful redemonstration of Walter Russell's principles of Transmutation; we had many dedicated volunteers and additions to our staff; we built a brand new road to **the PALACE**; the high point of the year was our annual Homecoming, a great success, with everyone enjoying the speakers, the food, the music, and each other.

We want you to know that we are all here to support your growth and help you in any way we can. Every organization is the combined energy of its founders, directors and the people drawn to the work. You

are very important to us!

May this holiday season bring you a wonderful awareness of the inner presence of Light, Love, beauty, joy, harmony, and true self-expression and result in the fulfillment of your heart's desire. We KNOW the secret of Life is **sharing our light and love with each other and the world.** Bless you!

With our combined Love to you,
Dr. Timothy A. Binder, President
Shirley Calkins Smith, Director of Student Affairs
Board of Directors
And Staff.

END OF QUOTING

Would this not seem most interesting—with ongoing aggressive litigation against these "Treasured Friends"? At the very time this was sent—there were surveillance teams following these people everywhere they went, intent upon suing for "contempt of court". What went wrong do you suppose? The PLEIADES CONNECTION series was long prior to this writing. Would it not seem contradictory, this action and these words: ".....Light, Love, beauty, joy, harmony, and true self-expression and result in the fulfillment of your heart's desire. We KNOW the secret of Life is sharing our light and love with each other and the world...." In prison perhaps—62 years old and in prison for contempt of court? This "Treasured Friend" feels she needs no enemies if these be friends. Does the right hand have any idea of that which the left hand does?

This is perhaps an error? Sorry—it is addressed directly to Mr. E.J. Ekker at his home address!

Lao was a remarkable woman—beautiful, talented, and perspicacious. You must understand that in considering the University of Science and Philosophy and possible errors of ones such as ourselves who long have honored such as WALTER RUSSELL, and further back prior to US&P was The Russell Foundation as we are told. At onset, we KNEW NOTHING OF EITHER! Why might this lack of human knowledge be resting with my scribe? Because the material offered her came BEFORE US&P and as for the Home Study Course—the "authors" came after the volumes were an uncopyrightable edition—and more material came from *The Universal One* MANUSCRIPT—long prior to Lao Russell or any Foundation and was never copyrighted! We do not quibble over this but it is most interesting that SOMETHING had to have happened to precipitate such animosity against our work—would it not seem?

Russell did NOT found the Russell Foun-

ation. How do we know? Because it says right here in their own material: "Well knowing that our present destructive basis of human relations was not solving personal, national and international problems, **LAO RUSSELL FOUNDED THE WALTER RUSSELL FOUNDATION IN 1948, WHICH IN 1957 BECAME THE UNIVERSITY OF SCIENCE AND PHILOSOPHY.....**"

"Performing a herculean task from which many strong men had turned away, Lao Russell restored a 52-room Italian Renaissance Marble Palace that had been the prey of the weather and vandals for 20 years and transformed it into a mountain top paradise with sculpture gardens that is visited annually by thousands from all over the world."

Well so far, it doesn't match much of anything Dharma and "we" do here—no students, no group, not even a home any more, no profits, no nothing but work. How could we be such an adversary OR "Treasured Friend"?

Ah, now perhaps we will see who this person is and why, just perhaps, there is dislike for Commander Hatonn—not to mention his lowly scribe without title or nobility.

"For additional information concerning Lao Russell, who is a member of "The International Platform Association", see "Who's Who of American Women", and "The National Social Directory". She is also listed in the 1968 Coronation Edition—which is the First Edition—of the "ROYAL BLUE BOOK" of England. This

is an international social and genealogical register with a key to present-day leaders who have achieved distinction on the regional, national or international scene as contributors...."

How much input might Walter have had in the formation of US&P considering his age of near 90 YEARS? Is it not possible that some of Walter's intentions may well have not been recognized and usurped by ones coming AFTER? I have no great bones to pick—but IF WALTER RUSSELL'S WORK IS TRUTH IN SCIENCE—IT WILL BE PRESENTED SOMEWHERE BY SOMEONE! I cannot believe that a latecoming home-breaker has the right to take a man's most precious possessions and garner unto herself all claims to self and HER FOLLOWING. If my opinion is misinterpreted as "contempt", then I no longer have any understanding of your narrow imprisoned world at all.

Lao Stebbing (Russell) made many very talented contributions to human consciousness through her writings on romance, marriage and LOVE as she called one of her books. Perhaps we again mistake the *flower blossom FOR THE TREE?*

Chelas, as with Newton: "If I see further, it is because I stand on the shoulders of giants who came before me!" Well, I stand on the shoulders, students, of giants such as Walter Russell who could see farther and beyond even Newton! So be it.

Raping Of Private Property Is Escalating Fast

7/28/93 #1 HATONN

PROPERTY SEIZURE

James Madison: "**It is NOT a JUST government, nor is property secure under it, where the property which a man has in his personal safety and personal liberty is violated by arbitrary seizures of one class of citizens for the service of the rest.**"

How can it be that you can continue to feel yourself to be secure when for the non-payment of a tax as small as a dollar, your property can be confiscated and sold? How can it be that, should a party place illegal substance on your property or within it, it can be seized and sold? How is it that a barrister (or a physician) who fails to pay his "CLUB" dues but knows the law and

represents the people, can be thrown out of a courtroom, arrested and incarcerated for "practicing without a license" when NO LICENSE IS INVOLVED? **Can you not see that the foreplay is over and the rape underway?**

How can it be that a paper such as this must consider closing its presses for lack of funds because enough are not interested to support its continuation?

How can the public continue to allow ones such as George Green and Joseph Pavlonski to have national and international audience on radio, etc., with money-making schemes and deals when Truth cannot sustain itself? How is it that incarcerated political prisoners continue in prison because we cannot raise enough money to continue court fees to have a hearing for them? How is it that authors

who face the risk of life in prison for printing material revealing political corruption and actual murder of thousands cannot have living expenses covered because not enough books will sell to allow the investment?

WHEN do you "believe"? Well, certainly, most of you do not believe until you read a thing we bring years prior, in a paper or from a conspiracy participant newsletter. Do I claim that newsletter writers are in conspiracy with the government?—NO, just against your best interests when it comes to YOUR money. You must understand that a "conspiracy" is two or more working in conjunction to manipulate others, **usually illegally**, but not always so—to defraud or cover some deeds or truth of situations. This can be in war, in investments, in politics, in crime (Mafia) or anything! When "they" do not wish it to be called "conspiracy", then it is usually called an Association, a Coalition or a Federation. If it be in the "churches" it is usually called Congregation for Unity, and so on. In the oil and diamond markets it is called Cartel. If books are written which are desired banned by the government or other "groups" it is called "Hate Crime", Racist and Copyright Infringement. And yet, if YOU allow this then you are receiving that which is equally deserved for, as the cycles revolve—it always comes spiraling back unto self.

Now the government considers recalling all money and using a debit system or worse. When this happens, readers, ALL FREEDOM IS GONE AND, THUS, IS HONEST MARKET CAPITALISM VANQUISHED.

Hans F. Sennholz: ***"The demand for money is subject to the same consideration as that for all other goods and services. People expend labor or forego the enjoyment of goods and services in order to acquire money. This is why individual demand and supply ultimately determine the purchasing power of money in the same way as they determine the mutual exchange ratios of all other goods."*** And then, of course comes the act of "acting": There are as many persons coerced into acting, not as they would prefer, but as others want, through majority rule (democracy controlled) as through totalitarian dictatorship. Where are YOU, America?

Most of you recognize the name, Gary North. He has some observations about money: "Money....should ideally be the creation of market forces. Whatever scarce economic goods that men voluntarily use as a means of facilitating market exchanges—goods that are durable, divisible, transportable, and above all scarce—are sufficient to allow men to cooperate in economic production. Money came into existence this way; the state only sanctioned an already prevalent practice...."

and on banking: "Banking, of course, also provides for the creation of new money. But as Professor Mises argues, truly competitive banking—free banking—keeps the creation of new credit at a minimum, since bankers do not really trust each other, and they will demand payment in gold or silver from banks that are suspected of insolvency." Well, the problem with BANKS is far beyond such a small statement. It is true, however, that along the way it became such that the citizens COULD NOT demand gold or silver in exchange for those notes you carry—but institutions could—until so much metal left the nation that there was not any to cover demand and with the onset of computer transfer it was done away with—except that foreign citizens, such as Israel, still demand much payment in GOLD! This depleted the coffers which were already empty by theft and transfer out of your country—right from, even, Fort Knox.

Testing And Discernment

7/28/93 #1 HATONN

TESTING AND THIS JOURNALIST,
HATONN

There are ones who have not studied, by far, MOST of that which we present—and yet are Biblical scholars and even represent that which they call "messengers" with "disciples" who now present that Hatonn is the "third angel" and/or the "testor" to your place. NO! I may well be a messenger who efforts to support you so that you can confront and win against "the testor" but THAT testor you present—IS MY ENEMY! I appreciate and respect that enemy for the gifts he brings in which we can grow, build, and rise above the temptations presented by that "testor". Rev. 9:10: *The third angel blew, and a great flaming star fell from heaven upon a third of the rivers and springs. The star was called "Bitterness: because it poisoned a third of all the water on the earth and many people died."* That referred to planet is called Wormwood, Herculobos, etc.

No, readers, I am NOT any of those angels, beings, prophets or seals. I am Aton, the One Light, and I come near with the messengers sent to fulfill the prophecies in these days of transition as if being manifest in the way of Revelation and Prophets of all time and ages. There are as many claiming to speak FOR ME as there are false Christs abounding in your place. My place is as "overseer" and Command of the Hosts sent as prophecy projects against

the day of tribulation to sound the trumpet and awaken the people of God unto their "way home"! We ARE blowing as hard as we can and yet millions sleep on—following this or that which offers seemingly better circumstances. There ARE NO BETTER CIRCUMSTANCES—for goodness sakes, we offer you a way into higher expression and a chance to reclaim physical freedom for a more blessed and wondrous expression of human form in radiance. I present ONLY as a messenger and guide—if you be tested by that which I bring, it is because you are steeped in that which came before and feel you must reconcile ME to FIT YOUR portfolio. When you have studied ALL (EVERY) presentation I have offered (even as some have studied the "Holy" books), then and only then will I accept any label as projected by any human individual.

In the higher realms of Truth—we do not have hierarchy as you perceive or accept in definition. We have "jobs" and for YOUR identification ease we will label ones as Commanders, etc. But it does not mean that we come as with Captains (except the true captain of a ship), Admiral, Sergeant and so on. YOU need those things and some would have a Colonel to lead—why?? IS GOD NOT ENOUGH? THE SERVANTS ON EARTH ARE EXACTLY THAT; HUMBLE, WITHOUT EGO NEEDS, PRESENT WHAT IS OFFERED AND DESIRE TO "LEAD" NOTHING—THEY ARE EMBARRASSED BY EVEN THE THOUGHT OF SUCH. Be most careful when you are given this kind of input from what you perceive as "higher resource" and "energy form"—it is 99% false speakers! "Bunches" of speakers are more confusing than none at all. Certainly in a given "Command" there is NO NEED FOR BUNCHES OF SPEAKERS OR EVEN "OTHER" SPEAKER. If Truth is flowing—why would another speaker be "more truthful"? Be careful, lambs, lest you follow the wrong herdsman. Note "little" things which often elude even the receiver. I had, yesterday, a message from one who claimed Haton speaking and was quite adamant about confusing the situation with George "Merke". There is no problem with George Merkl—it is EXACTLY as it should be—why do you need to meddle in it? My name is not Haton—it is Hatonn and I did NOT give such a message. Then this one moved on to Sananda who disclaimed ever speaking through one Desireé; that is false receiving. Sananda, the Christ now returning, certainly DID SPEAK THROUGH AND TO DESIREÉ—further, why would one LIMIT GOD IN WHAT HE WOULD OR WOULD NOT DO? Next, there was a speaking by Commander Ashtar. There is no Commander "Ashtar" as such. There is A Commander of the Ashtar Command. The Ashtar Command is a record-data base of computer capability to surpass anything else in the universe. The

purpose of that Command is not to COMMAND this transition but to be available with every being located and "wired" in case of massive lift-off of species from your planet. So many seem to want some twin flame or duality WITH Ashtar—even in physical manifestation, if it were so, how could you have duality with a computer data base?

Do I say these things to belittle or bring embarrassment? Certainly not—it is to warn ones that they are playing in a dangerous game wherein THEY are the pawns and are being deceived.

ARE THERE NO OTHER RECEIVERS? OF COURSE THERE ARE—BUT THEY DO NOT COME FORTH WITH CONFUSING OF THE ISSUES. THE TIME IS SO SERIOUS UPON YOUR PLACE THAT ONES NOW HAVE MISSIONS AND TASKS WHICH ARE SPECIFIC. ALL MUST BE HEARING INNER GUIDANCE—DO NOT CONFUSE IT WITH RECEIVING INSTRUCTIONS TO PASS ON TO FRACTURE THAT WHICH IS ALREADY IN PERFECT WORKING CONTROL.

This neither means that I am telling YOU what to do or what not to do—I say, take special care and see what you are

doing for enlightenment does not fall all over you like a snowstorm—it takes study, work and growing. It certainly does not feed into the "druthers" of individuals as to what they "want" to do. You can do anything you wish—why would you BLAME a voice from outer ethers and another's brain wave for that which you do? God FIRST gave you REASONING and he expects you to use it—all we are basically doing—is CAUSING YOU TO REMEMBER! YOU HAVE FREEDOM TO DO THAT WHICH YOU WILL.

The Institute, Gold And Deflation

7/28/93 #1 HATONN

In the line of "remembering", I am now a bit irritated at you who so quickly forget what we said at onset of the Institute. In all the fracas over gold and theft and receiver-ship and other claims and accusations—you have forgotten WHY you even invested your participation. We wrote many, many hours on what was anticipated in the market place and what kind of a "deflationary" depression or collapse you could expect. George Green may well have had other fish to fry but WE DID NOT. The participation is becoming more valid every day that passes. It was neither "short term" nor to "clean up" in the market. It was to give some security to assets, provide collateral for our work—such as the paper, publications and projects. There are not two out of a hundred investment managers who would not recommend gold as a partial investment and hedge. We do also recommend a small amount of assets into self-held security in coins or something—but, as in 1933, GOLD WILL BE CONFISCATED WHEN THE ASSETS ARE DESIRED BY THE GOVERNMENT. We do not HOLD GOLD for the heck of buried treasure. The gold is collateral to be BORROWED against for working funds.

Now, was I simply a "crazy alien" to suggest that gold would double from its low of the last four years? Crazy? Let me share with you an article from the *San Francisco Chronicle* "Business" section, Thursday, July 22, 1993:

Herb Greenberg, Business Insider:

IS GOLD HEADED FOR \$1,500-PLUS AS DEFLATION HEDGE?

QUOTING:

From the anything-is-possible department: Gold is often thought of as an investment hedge against inflation, but Boston money manager Paul Stuka and others are buying it as a hedge against deflation. Stuka is one of the few willing to go on the record with projecting **that gold will rise to \$1,500 to \$2,000 an ounce in the next three to five years.**

Before you write Stuka off as a tarnished kook, consider that from 1985 to mid-1986 he managed the Fidelity OTC Portfolio. The fund **gained 69 percent** in 1985 and **another 11 percent** in 1986. He now runs his own investment firm, Stuka Associates, where gold options and stocks (a long list that includes American Barrick and TVX Gold) have been a growing part of his portfolio for the past two years.

Stuka's target of \$1,500 plus is about three times the near-term target of most gold bugs, but that doesn't faze him. "Anyone who saw the Dow at 750 in 1982 would have thought you were crazy if you said it would rise to 3,000," he says. "Bull markets always go much farther than anyone thinks."

What makes Stuka's projection so noteworthy is its deflationary twist at a time when many economists are obsessed with the prospect of inflation (which is one reason many people have been *buying* gold.)

According to the deflationists, steadily falling prices in department stores and other parts of the retail economy are just

the start of a series of events which will culminate in deflationary fireworks when stock prices fall.

If everything goes like clockwork real estate prices will also resume their decline. "Then you'll have the worst of all worlds—deflation in tangible assets and deflation in paper assets," says Bob Hoyer, a devout deflationist, who runs Quantum Economics in Vancouver.

Which brings us to gold: Deflationists say it will be a safe haven if prices of everything else really do collapse. The last big round of deflation in the United States started in 1929. Although the price of gold was fixed at the time, Hoyer says its purchasing power increased for 17 years.

"If you consider that gold is money, and in deflationary periods the purchasing power of money increases, then the purchasing power (or price) of gold will increase," Hoyer says.

What could derail this scenario? The government's ability to print enough money to keep the economy going, Stuka says, "and then we enter this wonderful world" of 2 percent economic growth and 2 percent inflation. "But it's really more of a question of how long you can hold it in that environment," he adds. "We believe 2 percent inflation is just a point you pass through on your way from 15 percent (in 1980) to a negative 10."

END OF QUOTING

Now with this in mind I can only suggest you get, as quickly as possible, several

JOURNALS—regarding economic circumstance, how to protect yourself and how to grow while maintaining security and privacy. I personally offered you at least four such **JOURNALS**. [#4 **SPIRAL TO ECONOMIC DISASTER**, #10 **PRIVACY IN A FISHBOWL**, #16 **YOU CAN SLAY THE DRAGON AND #17 THE NAKED PHOENIX**. [See page 14.]

For you who would like to see this paper and publications continue but cannot see your way to simply "gift" funds—please consider participation in this plan of loaning the money to this business group through the Institute (now protected under law from raiders) so they can purchase gold at this price, borrow against the collateral (always the note itself is covered with the lending bank) and continue to wait for the price of gold to increase. **IT WILL!** I expect it to go to \$5,000 at some point as the Elite try to bring it under control. This means that, however, the holding of gold assets personally is **VERY, VERY DANGEROUS FOR THE GOVERNMENT WILL CONFISCATE IT, MOST CERTAINLY, AT THAT PRICE. THEY WILL CONFISCATE COLLATERAL ASSETS FROM THEIR OWN BANKS—LAST!!!** Is this a guarantee of some kind? What mean you? What guarantees do you have in this world? This is as nearly careful planning and hedging as you are going to find anywhere—but the One World Government **PLANS TO HAVE IT ALL—SO MIGHT IT NOT BE WISE TO USE SOME OF YOUR ASSETS WHILE YOU YET CAN—AGAINST THE POSSIBILITY OF GETTING THE PUBLIC INFORMED IN TIME TO POSSIBLY CHANGE THIS BEAST COME AGAINST YOU?** It is, as always, **YOUR** choices. I would suppose that a special "publication" fund could be specifically set forth and it becomes a **WIN-WIN** project instead of everybody is going to lose—as it is going.

PEROT POWER

Ones ask me "why" Perot?—when he seems to be a big money person and we don't really want him for president. Why? He has shown that **HE WILL LISTEN TO YOU—AS CITIZENS**. You have to understand that sometimes the "higher" you get in the morass of Elite, the less you **REALLY** know. You have to have **SOMEONE** that could win, don't you? Who else do you have with even the possibility of being noticed, much less **UPSET** the two party **FIXED SYSTEM?**

This, also, is a place **WHERE YOU CAN GET INVOLVED AND NOT BE SINGLED OUT FOR "TAKING-OUT"**. The "smart money" (whatever that means) says he'll never be president. That may well be but if he can't pull it off—nobody can. However, it looks more and more like the "smart money" just may be wrong.

Here is an article which was printed in

U.S.A. Weekend, July 16-18, 1993. I think it worthy of your undivided attention. If you have no leader to place in the harness, you have no way to pull the team.

QUOTING:

From the smoke-filled rooms of the Capitol to the smoke-free offices of the Clinton White House, Washington, D.C., insiders are finding it hard to accept the fact that Ross Perot, like Elvis Presley and rock 'n' roll, is here to stay.

It was widely assumed that the little Dallas billionaire would ride off into the sunset after last fall's presidential election, having made his point, spent his money and enjoyed his 15 minutes of political fame.

Democrats and Republicans alike have been eager to see Perot go away so they can get down to the task of appealing to and divvying up his supporters. Bill Clinton, who may well have won the presidency because of the votes that Perot denied to George Bush, even suggested that his success could be gauged by his ability to appeal to the 19 million voters who in the election became the "Perot vote".

So far, however, Clinton's appeal to these voters appears virtually non-existent. Even after taking his message directly to Perot country with his "town meetings", polls show that Perot voters neither believe nor agree with the president, while Perot himself dismisses Clinton as a "middle manager". Republicans, sensing Clinton's lack of appeal to these voters, are trying to sound like Perot. They've been burning up the telephone lines to Texas in the hope that he'll actually say something nice about them, and then disappear.

"I'm less concerned about Perot than about the 19 million Americans who voted for him," says Haley Barbour, the Republican Party chairman. "Most of these had voted for Bush in 1988 and Reagan before that. In 1992, they were dissatisfied because they didn't think we'd adhered to traditional Republican principles. Our goal is to win back their confidence."

A worthy goal. But the interesting aspect of the Perot paranoia sweeping Washington is that even the most fearful discount the idea that Perot might deny the White House to both major-party candidates in 1996. Both the Republicans and the Democrats believe they need the "Perot vote" to win a two-way contest the next time and both fear that, in a three-way race, Perot might hurt their candidate. But few take seriously the idea that he might actually win such a race.

They should.

If the current trend keeps up, Perot and his "volunteers" may soon be in position not only to challenge, but actually to topple,

the president and the two-party system as we know it. **[H: See, right here, is the way to go—they have said it—it certainly CAN be done and then, by popular demand the man himself WILL listen to you—the people. It also becomes evident that the stronger the man becomes the harder it is for the adversary to do anything to him or take him out by force or violence. It is up to YOU to see that he stays safe, open and POPULAR!]** The inability of the Washington establishment to realize its endangered status is itself a testament to its isolation from the needs and desires of the American public.

True, it is extremely difficult for a third-party or independent contender to win the presidency. Our system was put together to favor two parties and make it difficult for minor parties to break through at the national level.

The Electoral College alone consigns most such efforts to political oblivion before they even get off the ground.

But more Americans conclude that, as former third-party candidate George Wallace once put it, "there ain't a dime's worth of difference" between Democrats and Republicans.

Perot, 63, is being taken more and more seriously outside of Washington. That comes through strongly in a poll commissioned by this writer for this article, conducted by Market Strategies, a GOP-aligned firm that polled for Bush's 1992 campaign. "The depth of Perot's support signifies more than his emergence as a third-party candidate," says Market Strategies' Steven Lombardo. "It may be the emergence of a three-party system in America again."

Historically, successful third parties have emerged when large numbers of people become convinced that neither major party is addressing serious problems. That is what happened before the Civil War, when the Democrats and Whigs were unwilling to come to grips with the growing public demand that slavery be abolished.

[H: The one thing to hold in your mind as you read this and nod your head in agreement. The two parties involved in YOUR NATION have no intention of ever having another election under your present form of government. If you overlook this primary point you are setting yourself up for betrayal. Is Perot a possible player in "that" game? It must not matter to you as citizens—you must have an alternative with which to unify and rally for if you are ALL DIVIDED at the time of collapse—you will never unify enough from the pressures which will befall you, to recover in your lifetime—or for many generations to come. Will the world last long enough? That also matters not—you must continue to continue as if there is all the "time" in the universe—you KNOW you will perish as will freedom as a way of life as you are going.]

The result was that a new party emerged quickly, the Whigs went the way of Tyrannosaurus rex, and within a few years a Republican, Abraham Lincoln, was in the White House. Few Whigs or Democrats had believed it could happen. Then as now, established politicians were among the last to believe radical change was possible.

The point, of course, is that what starts out as a protest can grow into something far more important if it is ignored or underestimated. Perot's success in harnessing the rage of average Americans—who have come to believe that Democrats and Republicans in Washington are more interested in their own perks than in solving real problems—should have been taken as a wake-up call to the leaders of both parties. But it wasn't. Clinton rode the same wave that fueled the Perot candidacy. But so far he has failed to translate his campaign rhetoric into reality.

The predictable result: The fires of grassroots outrage have been fueled, not put out. Politicians rarely realize that every broken promise alienates more and more voters, who either don't vote next time or begin actively looking for Electoral alternatives.

As Perot travels the nation, organizing his followers, and honing his anti-establishment message, he is building on a foundation that, thanks to the shortsightedness of his Washington critics, could make his United We Stand America a major factor in the 1994 congressional elections—and win him the White House in 1996.

True, his popularity has dropped in some recent polls, and Washington has started to conclude that, in political terms, Perot has "peaked". But that ignores his solid base of support and the willingness of voters to back United We Stand America candidates. "His numbers have been up and down over the past several months," says Lombardo, the Market Strategies pollster, who points out that Perot's high ratings in this poll might be as much a reflection of the president's unpopularity than of Perot's popularity. **[H: And remember—polls are intended to present exactly what is desired be presented!]** "But the essence of Perot's message is still attractive to a significant group of the electorate." Half of those polled said that they considered Perot's criticisms of Clinton fair, while just 35 percent said they considered it unfair.

Given the bipartisan nature of his support, Perot might be expected once again to mount an independent campaign if he decides to run again in 1996. But it is possible—prepare yourself for another idea that the political establishment will hoot at—that the Texan will convert his troops into a boarding party that could challenge the Republican leadership in the primaries and win the party's presidential nomination. Remember: Six million Republicans voted for Perot last November, and the number of Republicans who support him

has increased since then.

[H: What you MUST remember is that the computer was FIXED and PEROT swept the nation with votes which were not reflected in the already "decided" election results. Even Bush ran, in the end, AGAINST HIMSELF! How short are your memories!]

That number is enough to win the Republican primaries in New Hampshire and Iowa, especially if the field is crowded—as it appears it will be—with U.S. Sens. Dole, Gramm and Lugar; U.S. Rep. Dornan; former Bush Cabinet secretaries Alexander Bennett, Martin, Kemp and Cheney; and Govs. Campbell (S.C.), Thompson (Wis.) and Voinovich (Ohio) as well as Pat Buchanan, Pat Robertson and Gen. Norman Schwarzkopf.

None of them has more support among Republican voters than Perot. And the results of the Market Strategies poll, showing that a Republican ticket headed by Perot would trounce Clinton in a two-way contest, should give both parties pause. "If he got serious, he would be a strong GOP candidate," says Jeff Bell, a Republican analyst. "But I'm not sure he is temperamentally suited to go through a grueling primary process. In his favor, he could successfully portray the other GOP candidates as part of the problem. The system is going to be even more vulnerable in 1996 than in 1992: The centralized forces in Washington will be under more suspicion."

If both parties can't soon find better answers for increasingly angry voters, Perot may be their answer in '96.

END OF QUOTING

Col. Gritz called me a "Judas-goat" at the time of the last election when I asked you to unify as "independents" and overwhelm the computer ballot system by voting for Perot. Not one of the "independent" candidates was willing to forego the ego trip to do such a thing. **YOU HAVE NO RESOURCE STRONG ENOUGH TO WIN AN ELECTION FROM THESE NEW WORLD ORDER CONTROLLERS. THE REAL CONTROL COMES FROM THE COMMITTEE OF 300 WORLD ELITE WRAPPING UP THEIR ONE WORLD GOVERNMENT TO ENSLAVE THE NATIONS OF THE PLANET. YOU CAN SEE IT EVERYWHERE YOU LOOK AT HOME AND ABROAD—ANYWHERE!**

Even if the whole government continues to decline, just to have unification under Perot gives you working power to hold against the thugs in power. Remember, the adversary MUST work in the dark in deceit and with lies. He cannot do well if the actions bring attention as with the North American Free Trade Agreement

bounced off him and you by Perot. It becomes a force of people with which to be reckoned. Every ray of light shone on the puppets playing in the government is a shot in the heart of the beast.

Look, for goodness sakes, what the government pigs are doing to the people in the flooded areas of the Mid-west. No help, no votes, lingering pain and agony—while aid is being dished out without recourse or charge to every country in the world! You have been sold-out, America—betrayed by the treasonists! The whole thing, from the floods to the lack of AID is a fully planned and orchestrated event. Let me share with you something shared with us.

Did everyone catch Elizabeth Dole's major slip on TV last week? She was commenting on what the Red Cross was providing the flood victims and reminded everyone that the Red Cross works on public donations. Then she said (this is NOT an exact quote, but it's close), **"We're going to need a lot of donations, not just for this disaster, but for the other disasters this summer."** The newscaster asked, "Are you expecting more disasters this summer?" She replied: **"That is what we've been told."** How interesting—in advance disasters? Well, with what is going on I suggest you WILL HAVE MORE DISASTERS, there have even been earthquakes along the Edwards fault in San Antonio, Texas, we are told—and that, chelas, is an INACTIVE fault.

This friend also writes that there is an outbreak of tuberculosis in San Antonio. The health official interviewed on TV said **it was a virulent, antibiotic-resistant strain, and he said the outbreak was not UNEXPECTED....**

Probably one of the most heart-clutching events, however, would at first SEEM to be the least important:

In July, 1992, I went to the public library (Main branch) in search of information on surviving a nuclear attack. There **was no government publication on the subject available** (in a city with 5 military bases!) and at that time I was told that: **"Those publications were pulled from the shelves a year ago."** It was suggested that I try the military libraries, which I did—only one had any information at all on preparing for a nuclear attack, but it dated back to the late 50s-early 60s and so was no longer relevant (i.e., use a door to make a lean-to against the outside of a building and crawl behind for shelter). Last week, July, 1993, I went to the library again to see if anything had changed. Nope, the only book in the entire library was **Nuclear War Survival Skills IN THE HISTORY SECTION**. I checked the government publications again, and found that NO informa-

tion on nuclear survival has been published by the government since 1991 (and, of course, the one publication done in 1991 is still **not available**)".

END OF QUOTING

If this is universally true then we will have to offer a portion of our paper to offering you that information. I can suggest our own JOURNAL, SURVIVAL IS ONLY TEN FEET FROM HELL and Arthur Robinson's *Fighting Chance*. There are also some excellent survival books, one I especially recommend is Janowsky's *SURVIVAL*.

However, you must be prepared for "rapid Make-do" and as of year before last we got material published by the Oregon Institute of Science and Medicine, Cave

Junction, Oregon. The book in point is called *Nuclear War Survival Skills, Updated and Expanded 1987 Edition*, by Cresson H. Kearny. You can also get "tapes". Also, we just received a full packet of information exactly directed to this subject from a reader petitioning us to run the material, it being non-copyrighted and it would only need reproduction for such a purpose as a newspaper. I shall discuss it with the staff and consider the possibility of devoting a whole paper issue to the subject. My wish for all of you who have property enough for a common "root cellar" is to consider digging same. You can store supplies in a temperature regulated environment and have the facility for emergency quarters also. It could be deep enough that with a cover you can plant your bedding flower garden or even

your garden with food products ON TOP of it. This could be landscaped and be made into a veritable hidden facility so that it could be most pleasing in the scheme of a garden. You could even run water to the given area and have an imitation rock garden with flowing recycled water and a small decorative pond, etc. Or if you like, simply a root cellar of any kind. If you cannot do that—then you could build a "trench" shelter for absolutely short-term cover and this could be placed under a gazebo or simply instead of a flower bed with just enough room to go within, have some stored water and potty facility and "sit" it out. I do believe we should offer you reminders of emergency care.

This chapter is getting too lengthy so please allow us a break. Thank you. Salu.

SPIRAL TO ECONOMIC DISASTER LIFEBOAT MEASURES IF YOU ACT NOW

BY GYEOGOS CERES HATONN
(J4) \$7.95 104 pages

(A4) \$20.00 BOOK ON TAPE (3 Tapes)

This JOURNAL contains details about our current economic malaise and waking up to some economic realities. Additional topics are: Exposing the "Grey Men" and the Secret Government, Their Manipulations, the Degree of Their Diabolical Capabilities and the Perfection of Their Plan--Depression Imminent--New Currency and Some Solutions--The Solution of Incorporation--The Nevada Secret--Prophecies--Sananda and Aton State 'How It Will Be'.

PRIVACY IN A FISHBOWL

BY GYEOGOS CERES HATONN
(J10) \$7.95 104 pages

This JOURNAL is part II of *SPIRAL TO ECONOMIC DISASTER* (J4). The government's thirst for information on its citizenry is unquenchable. Is privacy possible? This document contains very pragmatic "how to" and tactical suggestions to help you legally "fade into the background". Additional topics: S&Ls--the Real Estate Market--Oil--Bonds--Precious Metals--the Internal Revenue Service--the New (traceable) Currency--The War on Privacy--Electronic Intrusion--Cashless Society--If Your Home Is Invaded--The Estate Plan That Never Dies--Special Report (Corporate Strategy).

YOU CAN SLAY THE DRAGON

BY GYEOGOS CERES HATONN
(J16) \$7.95 292 pages

This JOURNAL reveals the history behind the unlawful establishment of the Federal Reserve System and the IRS. Hatonn discusses the history and purpose of the unlawful 16th Amendment, as well as other UNCONSTITUTIONAL actions taken by U.S. Government legislators. Related topics: IRS Code References--Taxpayer vs. Nontaxpayer--Indirect vs. Direct Taxes--What the U.S. Constitution Really Says--Citizen of the United States vs. U.S. Citizen--Lawful vs. Legal--How to Restore the Original U.S. Constitution.

THE NAKED PHOENIX

BY GYEOGOS CERES HATONN
(J17) \$7.95 211 pages

Hatonn continues to unfold the conspiracy behind the Federal Reserve System and its member Banks. Learn why the Federal Reserve Banks are NOT government institutions and what the purpose and power is behind these PRIVATE credit monopolies. Learn WHO is behind this evil institution which has impoverished the people of the United States and bankrupted the U.S. Government. Related topics: U.S. Fed's Relationship with United Nations--The Rockefeller Control of Education--IMF--Rep. Louis T. McFadden's Battle with the Banksters--The Sherman Antitrust Act.

SHROUDS OF THE SEVENTH SEAL

BY GYEOGOS CERES HATONN
(J24) \$7.95 198 pages

This JOURNAL is MUST reading for anyone who desires to know the TRUTH about the causes of the war in the Middle East. We are given information about: Mental Health among the U.S. Troops--Is the U.S. Sending Soldiers to the Persian Gulf in Chains?--Political Zionism is Born--Israel's Racist Policies and Arms Industry--Zionists Simply Eliminate Opposition--Doubles, Robotoids and Replicas--Executive Orders and The Protocols--Blood and Destruction Behind the Curtain of American-Sponsored Censorship.

BURNT OFFERINGS

BY GYEOGOS CERES HATONN
(J23) \$7.95 218 pages

Hatonn gives us an excellent overview of why the world is on the downward path to ONE WORLD GOVERNMENT, the "NEW WORLD ORDER" that President Bush mentions many times and how the Middle East War is the beginning of the Battle of Armageddon, the greatest battle to ever be fought on this planet. He gives us details of hardships even the Americans must be prepared for, including: invasion, destruction of our troops, starvation, terrorists and even concentration camps here in the United States.

BLOOD AND ASHES

BY GYEOGOS CERES HATONN
(J18) \$7.95 231 pages

"To understand the lies given unto you this day in your 'Middle East' you must know of the lies told to you by your government during the decade past. The traitorous Zionist plan to win world domination through an American nuclear first strike on Russia has not been abandoned, even though Russia has thwarted several attempts."
"The 'Biblical Prophecies', written not by God but by Satan, are being played out by a mankind brainwashed and blinded to believe them to be inevitable."
Topics are: Exposing the "Grey Men" and table.

FIRESTORM IN BABYLON

BY GYEOGOS CERES HATONN
(J19) \$7.95 166 pages

History is repeating itself--in ever shortening cycles. It is he who can learn from history who will prevail.
This JOURNAL is a review of the several attempts to start Nuclear War I during the past ten years and how that relates to the Middle East "Crisis in the Gulf". The world teeters on the abyss of total all-out nuclear war, the military bases of the U.S., foreign and domestic, have been stripped of men and equipment, and the (controlled) news media works diligently to obscure the TRUTH. Also included: United Nations Charter (22 pgs).

SURVIVAL IS ONLY TEN FEET FROM HELL

BY ASHTAR
(J6) \$7.95 136 pages

Commander Ashtar details the truth behind nuclear energy misconceptions and how to prepare for the probable Nuclear War which is planned. He explains that the U.S.A. has no underground Nuclear Shelter defense system, except for the Elite. Additional topics: The Ten Feet Underground Protection--Probable First Strike--Fallout Danger--Cost Per Person for a Shelter--Why You Must Prepare--Plans While America Sleeps--The Nuclear Deterrent Once Available No Longer Exists.

Thank You From Russbacher

GUNTHER KARL RUSSBACHER
18701 Old Highway 66
Pacific, Missouri 63069

July 25, 1993

To All the Readers of Contact:

Please know that I have received a great many letter and post cards without return addresses. Although each and everyone of these mailings have been ever so greatly appreciated, it does pain me not to be able to answer each writing in a more personal manner.

Each of you need to know that your correspondence has meant the difference between having a good day and having a bad one. It is your letters, thoughts and well wishes that make the difference between and permit me to state that "I have had a good day?" All I can say to the many who did not choose to included their return addresses is to unequivocally state...."thanks for being there for Rayelan and for me. You have our greatest thanks and admiration."

Having said that, I would ask each of you to, in the future, include your return address, in order that I might properly issue thanks for your thoughts, well wishes, and comforting statements. You mean more to me than you can conceivably imagine at this time. Please do not deprive me of the right to write a personal note of thanks.

[Editors note: We do not think anybody should be made to feel they are irresponsible because they fail to give someone their address after writing to help and wish them well. Your privacy is your own business.]

Stay tuned to the Contact for further information as to our status in the fight to save our country from the clutches of the adversary. Each week a segment of the "survival plan" is presented for your reading and absorption. Don't allow this simple plan to fall upon deaf ears. Remember that the lives of your loved ones may very well hang in the balance. Read and understand the TRUTH, for it will....ultimately....set you free!

Part two of "Operation Clydesdale" is being edited for errors and accuracy at this time. It will soon be made available to you. I apologize for being a bit tardy in its completion, but due to an ongoing court battle, my efforts have been diverted to properly prosecute an issue before the United States District Court for the Eastern District of Missouri. You will be kept apprised of further developments.

Lastly, I would urge each and every reader

to write to the Contact staff, expressing their sincere and profound thanks to the men and women who continue to bring you the truth. **[Editors note: Please do not write, we know you care.** Your postage and time can be put to better use helping others, as we know you do. We are as appreciative of your efforts as you are of ours.] Let them know that you value them for their valiant efforts, as they strive to educate us even in the face of great adversity. They are to be praised

for their efforts.

Keep the letters and cards coming! Your thoughts and well wishes shall always be treasured, as they are read and re-read to change the darkness of night into the amber glow of a new morn.

I sign with love and greatest respect,

Your friend and servant....always,

Gunther

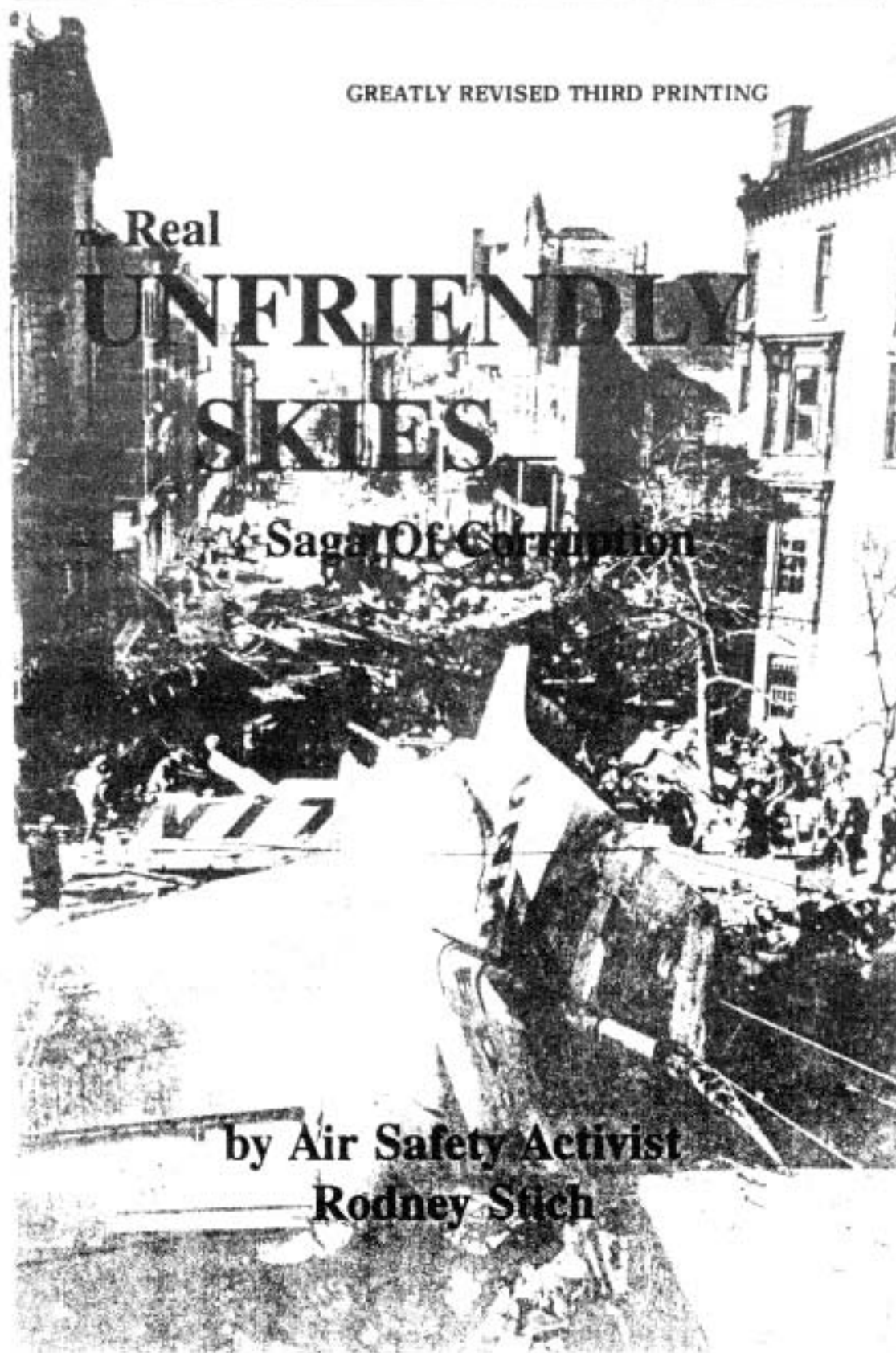

GREATLY REVISED THIRD PRINTING

Real UNFRIENDLY SKIES Saga Of Corruption

by Air Safety Activist
Rodney Stich

Available NOW for \$22.00 + \$2.50 shipping and handling from:

Phoenix Source Distributors, Inc.

P.O. Box 27353

Las Vegas, NV 89126

(800) 800-5565

Elite Tinkering With Gold Market Again

7/29/93 #1 HATONN

GOLD

I feel the "gold" situation bears attention calling—it was trading at well OVER \$400 today and closed out the day trading at \$400. It is hard to tell just what "they" are going to do but I would be remiss if I failed to remind you that you may well not see lower prices for a long time in that commodity and many of you continue to petition me to tell you when it hits certain levels. This is the only way I have to do so. So, if YOU aren't interested in the Institute OR Gold—please just overlook it as we give you an almost day by day comment for the next little while. Every dollar gain on the market settles the Institute into better stability.

George Green is back on a "calling people" circuit—all the way to ones in Canada to tell them that there will now be four new attorneys to insure he gets his rightful gold and "receiver" the Institute. This WILL NOT HAPPEN! George Green and Gary "Ray" Anderson are in DEEP Yogurt! Green is in Bozeman, Montana at the time of phone calls on Monday. He is going to push his "luck" until the point arrives where other problemed people are going to do something—and I fear it may well be quite unpleasant. No, it isn't me—these "citizens" have far bigger and harder fish to fry than a "Guardian Angel Ghost Writer"! If there is more by the first of the week I will inform you readers. If this isn't brought to an immediate halt there are many who plan to file separate corporate and personal legal proceedings against George, Perry and Fort within the next few days. The original letters said as much and yet those letters of demand have been ignored by EVERYONE. Ones petition me to ask what do they do now as they do not hear anything back from anyone. The whole thing was being handled through the Constitutional Law Center as I understand it so I will relay the inquiries. Things will be "tied up" until the issue is settled and this is terribly inconvenient for you ones who are needing to make settlement in your own right. Just know that as gold increases so does the value of your participation. To work through the red tape and obscene judicial system is INCREDIBLE and the legal point is not "justice" or who is right—it is which attorney can sell the biggest lies—it is a standing joke within the "profession". I personally think it is despicable and the cartoon quips are getting old. The lawyers doing a good job are all but overwhelmed.

Defrauding America

A PATTERN OF RELATED SCANDALS

Makes the Godfather Saga Pale by Comparison

Dirty Secrets of the CIA and other Government Operations

Written by an insider

*Author of
UNFRIENDLY SKIES*

Available NOW for \$22.00 + \$2.50 shipping and handling from:

Phoenix Source Distributors, Inc.

P.O. Box 27353

Las Vegas, NV 89126

(800) 800-5565

The ultimate measure of a man is not where he stands in moments of comfort and convenience, but where he stands during challenge and controversy.

Martin Luther King

Earthquake: PLANNED

Big One

Stalled *Temporarily*

7/29/93 #1 HATONN

TURNING TO EARTHQUAKE
ACTIVITY

The following article will seem a bit "much" to a lot of you readers but I want to urge you to read it, technical as it may seem. You are still at such risk this very day, the 29th, that "I" can't see how it is going to go even as we write.

We are working into the night here to get this to you for you will note that references will be coming out within the week regarding "Tidal Wave" danger far beyond anything imagined along the West Coast. I could give you an overview and you would shake your head and say, "Well, there he goes again!" I think you should get it as given by the top scientists in their field from *SCIENCE*, Vol. 261 p.433-438, 1993 (hardly off the press and not yet even to subscribers). I asked that this document be tracked down and Dr. Oppenheimer was kind enough to personally FAX the paper to us so that we can share with you immediately. **The reason I take the time to possibly "bore" a lot of readers with this information is BECAUSE quite a few scientists are waiting for it and this is the quickest method of reaching them. I think you readers have no idea WHO reads CONTACT!** Since it is a technical scientific paper I wish to recognize the scientists involved, D. Oppenheimer, G. Beroza, G. Carver, L. Dengler, J. Eaton, L. Gee, F. Gonzalez, A. Jayko, W.H. Li, M. Lisowski, M. Magee, G. Marshall, M. Murray, R. McPherson, B. Romanowicz, K. Satake, R. Simpson, P. Somerville, R. Stein, D. Valentine. I have further asked Commander Soltec to "hold up" on this subject until after I sprinkle it all over your heads. It is too important to await general discussion on the subject because the "Big One" was "planned" for

today, readers! The hold-off revolves around the shuttle launch or non-launch as the case may be—but you are skating on ice so thin as to already be in the water to your ears and no one seems to pay a bit of attention.

D. Oppenheimer, J. Eaton, A. Jayko, M. Lisowski, G. Marshall, M. Murray, R. Simpson, and R. Stein are with the U.S. Geological Survey, Menlo Park, CA 94025. G. Beroza and M. Magee are in the Geophysics Department, Stanford University, Stanford, CA 94305. G. Carver, L. Dangler, and R. McPherson are in the Department of Geology, Humboldt State University, Arcata, CA 95521. L. Gee and B. Romanowicz are at the University of California, Seismographic Station, ESB 475, Berkeley, CA 94720. F. Gonzalez is with the National Oceanic and Atmospheric Administration's Pacific Marine Environmental Laboratory, Seattle, WA 98116. W. H. Li with Geological Sciences, AJ020, University of Washington, Seattle WA 96195. K. Satake is in the Department of Geological Sciences, University of Michigan, Ann Arbor, MI 45108. P. Somerville is with Woodward-Clyde Consultants, Pasadena, CA 91101. D. Valentine is in the Department of Geological Sciences, University of California, Santa Barbara, CA 93108.

I ask that this paper be reprinted as near as possible to the original. You ones MUST start listening to what your own scientists are telling you. I simply feel that you ones have grown numb to the facts and that is fine—but to ignore warnings and then blame your inaction on ignorance—is not acceptable. I remind you—there will be very, very LARGE quakes along the faults across the nations—and very, very BIG ones along the West Coast areas of the Americas—please, consider ALL ramifications as you prepare and take stock.

QUOTING:

THE CAPE MENDOCINO,
CALIFORNIA, EARTHQUAKES
OF APRIL 1992: SUBDUCTION
AT THE TRIPLE JUNCTION

The 25 April 1992 magnitude 7.1 Cape Mendocino thrust earthquake demonstrated that the North America-Gorda plate boundary is seismogenic and illustrated hazards that could result from much larger earthquakes forecast for the Cascadia region. The shock occurred just north of the Mendocino Triple Junction and caused strong ground motion and moderate damage in the immediate area. Rupture initiated onshore at a depth of 10.5 km and propagated up-dip and seaward. Slip on steep faults in the Gorda plate generated two magnitude 6.6 aftershocks on 28 April. The main shock did not produce surface rupture on land but caused coastal uplift and a tsunami. The emerging picture of seismicity and faulting at the triple junction suggest that the region is likely to continue experiencing significant seismicity.

[H: I want you READERS and tape "getters" to remember back—Commander Soltec told you all about the seriousness of this particular quake activity AT THE TIME.]

On 25 April 1992 at 18:06 (UTC), a surface wave magnitude (M) 7.1 earthquake occurred near the town of Petrolia, California (Fig. 1). The main shock was followed the next day by two M 6.6 aftershocks at 07:41 and 11:41, located offshore about 25 km west-northwest of Petrolia. These three earthquakes and more than 2000 recorded aftershocks illuminated the configuration of the Mendocino Triple Junction, where the Pacific, North America, and southernmost Juan de Fuca (Gorda) plates meet. The occurrence of a M 7 earthquake is not

unusual at the triple junction; over 60 earthquakes of Modified Mercalli intensity $+/-VI$ (1) or $M +/-5.5$ have occurred there since 1853 (2). However, this earthquake sequence may have provided the first direct evidence of interplate seismicity and thus impacts regional hazard assessment. In this article, we describe geophysical and seismological observations and discuss implications for seismic hazards in the Pacific Northwest.

Damage estimates ranged from \$48 million to \$66 million, and President Bush declared the region a major disaster area. Much of the damage resulted from the main shock; however, fires triggered by the first large aftershock destroyed most of the Scotia shopping district, and both large, off-shore aftershocks caused additional structural damage. The relatively low incidence of injuries and structural damage caused by this sequence is primarily the result of low population density and the predominance of small, wood-frame structures in the epicentral area. The sequence caused 356 reported injuries, destroyed 202 buildings, and caused damage to an additional 906 structures primarily in the towns of Petrolia, Ferndale, Rio Dell, Scotia, and Fortuna (Fig. 1) (3). It also triggered numerous landslides and rock falls and caused widespread liquefaction in local river valleys. Analysis of 1296 surveys in the north coast area indicate that the Modified Mercalli intensity peaked at IX in the Petrolia region and decreased in approximately a radial pattern around the epicenter (Fig. 1). Both of the two large aftershocks produced peak intensities of VIII, although the pattern was somewhat different from the main shock.

TECTONIC SETTING

The Cape Mendocino earthquakes are a response to ongoing plate motions between the Gorda, North America, and Pacific plates at the Mendocino Triple Junction. The Gorda plate is converging on the North America plate at about 2.5 to 3 cm/year in the direction N-50°-E to N-55°-E (4). The seaward edge of Gorda plate subduction is marked by an abrupt change in sea-floor topography and by the western limit of the accretionary prism imaged in seismic reflection profiles (5). Active folds and thrust faults in Franciscan Complex and Cenozoic rocks and sediments of the overriding North America plate are parallel to the seaward edge of the Cascadia subduction zone (6).

Rigid-plate theory predicts oblique convergence of the Gorda plate with the Pacific plate at 5 cm/year in the direction N-115°-E (4). Translational motion occurs along the east-west-trending, vertical, right-lateral Mendocino transform fault, whereas the convergence results in internal defor-

mation of the Gorda plate. The attendant Gorda plate seismicity recorded in the 17 years before the Cape Mendocino sequence (7,8) (Fig. 2) has been concentrated in two parallel zones with a combined thickness of approximately 15 km. In the region of the Cape Mendocino earthquake, most seismicity has originated at depths greater than 17 km; the hypocenter zone dips about 6° eastward between 124.75° and 123.25°W, at which point the dip increases to about 25° (9). Most $M > 5$ earthquakes within the Gorda plate exhibit left-lateral motion on steep northeast-oriented faults (7,10) that relieve convergence between the Gorda and Pacific plates through slip on preexisting planes of weakness inherited at the Gorda Ridge (11).

The San Andreas fault marks the principal Pacific-North America plate boundary south of the Mendocino Triple Junction. Triangulation data and observations of ground cracks indicate the fault ruptured as far north as Point Delgada in 1906 (12), but its location farther north is uncertain. Some studies place it immediately offshore (13), but others suggest that it merges with onshore faults at the triple junction (5). Geometry requires that the Pacific plate is also in contact with the North America plate along the Mendocino fault above the subducting Gorda plate.

Until the Cape Mendocino earthquake, few earthquakes were recorded with focal mechanisms that indicated slip on the Cascadia subduction zone. However, comparisons of the age, spreading rates, physiography, and seismicity of the Juan de Fuca-Gorda plate system with other subducting plates suggest that it does not subduct seismically but instead **is locked and capable of generating MAJOR earthquakes** (14). Paleoseismic evidence of large, late-Holocene subduction earthquakes is present along the subduction zone in submerged and buried wetlands (15), raised marine terraces (16), and surface displacement on thrust faults that may be genetically related to large subduction events (17). Radiocarbon dating implicates that at least three episodes of seismicity of similar age are represented in the stratigraphy from central Washington to northern California in the last 2000 years; the last episode occurred at about 1700 A.D. (17).

OBSERVATIONS

Seismicity. The hypocenter of the 25 April 1992 mainshock was 4 km east of Petrolia at a depth of 10.6 km (Fig. 3). A focal mechanism determined by the invention of teleseismic mantle Rayleigh waves and aftershock locations indicates nearly pure thrust motion on a N-10°-W-striking fault plane that dips 13° to the east-northeast (18) (Table 1). The location of the

hypocenter at the southeast end of the aftershock zone suggests that the fault ruptured unilaterally to the west (19). Most aftershocks <12 km deep (Fig. 3, open circles) occurred within 10 km of the coast in a region bounded on the east by the main-shock epicenter, on the south by the Mendocino fault, and on the north by a west-northwest trend of earthquakes. The location, depth, and orientation of the rupture plane are consistent with the absence of surface faulting onshore.

The two $M 6.6$ after shocks were 30 km west of the main shock at depths near 20 km, and their mechanisms indicate right-lateral strike-slip motion on planes striking to the southeast (20) (Fig. 3 and Table 1). The slip plane of the first aftershock is unknown because of the paucity of aftershocks. However, the second aftershock was within a trend of smaller aftershocks at depths of 14 and 30 km on a southeast-striking plane that dips about 80° to the southwest (Fig. 3B, ee'); this orientation is consistent with the focal mechanism. The depths and mechanisms of the two large aftershocks provide evidence that rupture took place on faults in the Gorda plate, distinct from the main-shock fault.

Although no large shocks ruptured the Mendocino fault during this sequence, many aftershocks occurred on the eastward projection of the fault (Fig. 3). The aftershock activity was bounded on the south where the distribution of hypocenters is near vertical and extends to a depth of 25 km (Fig. 3B, bb'). If this marks the boundary between the Gorda and Pacific plates, then the lack of any aftershocks in the Pacific plate suggest that the main shock represented strain release between the Gorda and North America plates. The mapped location of the Mendocino fault in this region is uncertain (5), and this east-west trend of seismicity may define the position of the Mendocino fault.

Source properties. The mechanism and location of the two aftershocks were similar, but the second aftershock exhibited a strong variation of amplitude with azimuth (Fig. 4). The seismic moment of the second aftershock was approximately twice that of the first, but amplitudes of the P wave for this event were as much as 10 times as large near an azimuth of 130°. This variation is most easily attributable to enhancement of the amplitude in the direction of rupture, known as directivity (21). Directivity in P waves is surprising because it requires rupture velocities that are a large fraction of the P-wave velocity. The high amplitudes and strong high-frequency content associated with the second aftershock may explain some of the differences in the intensity patterns for the main shock and two aftershocks. Although the second aftershock had 25% of the moment of the mainshock, it has larger velocity ampli-

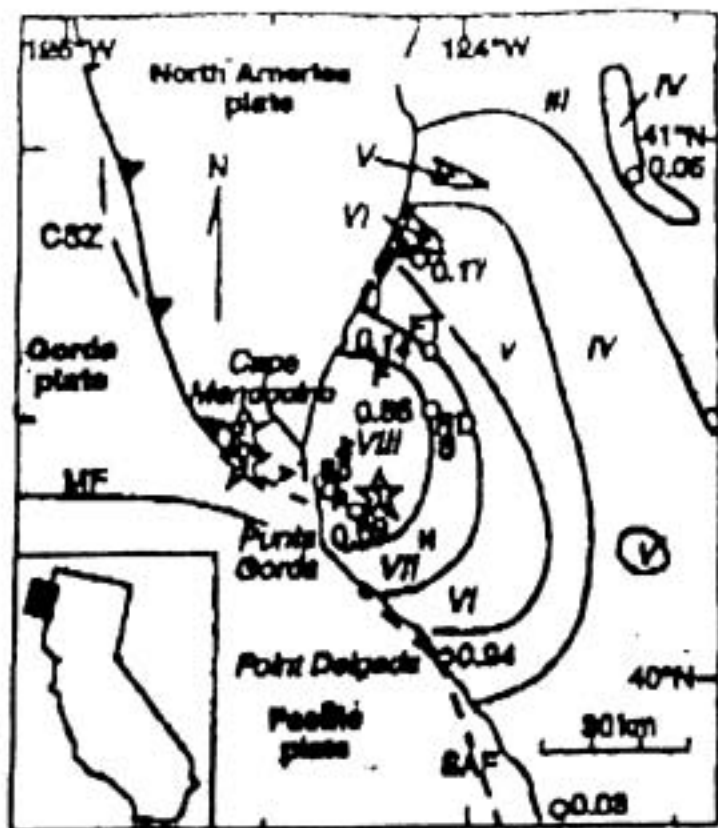

Fig. 1. Simplified tectonic map in the vicinity of the Cape Mendocino earthquake sequence. Stars, epicenters of three largest earthquakes; contours, Modified Mercalli Intensities (values, Roman numerals) of main shock; open circles, strong motion instrument sites (22) (adjacent numbers give peak horizontal accelerations in cm/s^2). Abbreviations: FT, Fortuna; F, Ferndale; RD, Rio Dell; B, Boonville; P, Petrolia; H, Honeydew; MF, Mendocino fault; CSZ, seaward edge of Cascadia subduction zone; SAF, San Andreas fault.

SCIENCE • VOL. 261 p. 433-438, 1993

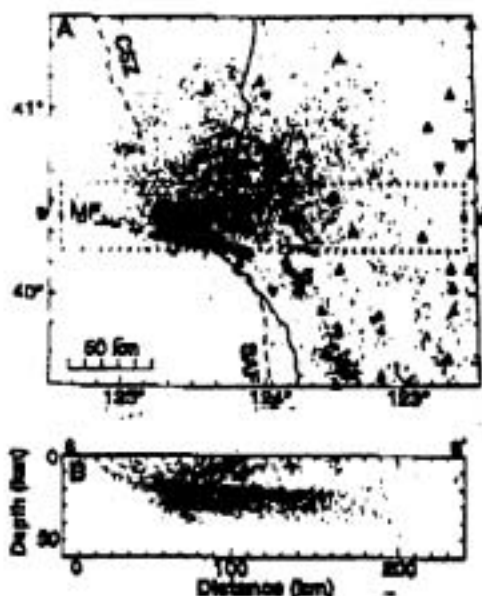

Fig. 2. Seismicity between August 1974 and time of main shock (10). (A) Locations of operating and discontinued seismic stations (upward and downward pointing triangles, respectively) at time of main shock. (B) Depths of earthquakes along cross section aa' . Depths west of longitude $124^{\circ}40'W$ are unreliable. Note the gap in seismicity between main-shock rupture plane at 10 km depth and pre-main-shock seismicity at depths greater than 17 km. The earthquakes at cross-section distance 200 km occur at depths greater than 35 km and begin to image the region of the Gorda plate where the dip increases. Earthquakes as deep as 30 km occur near longitude $122^{\circ}10'W$ (9).

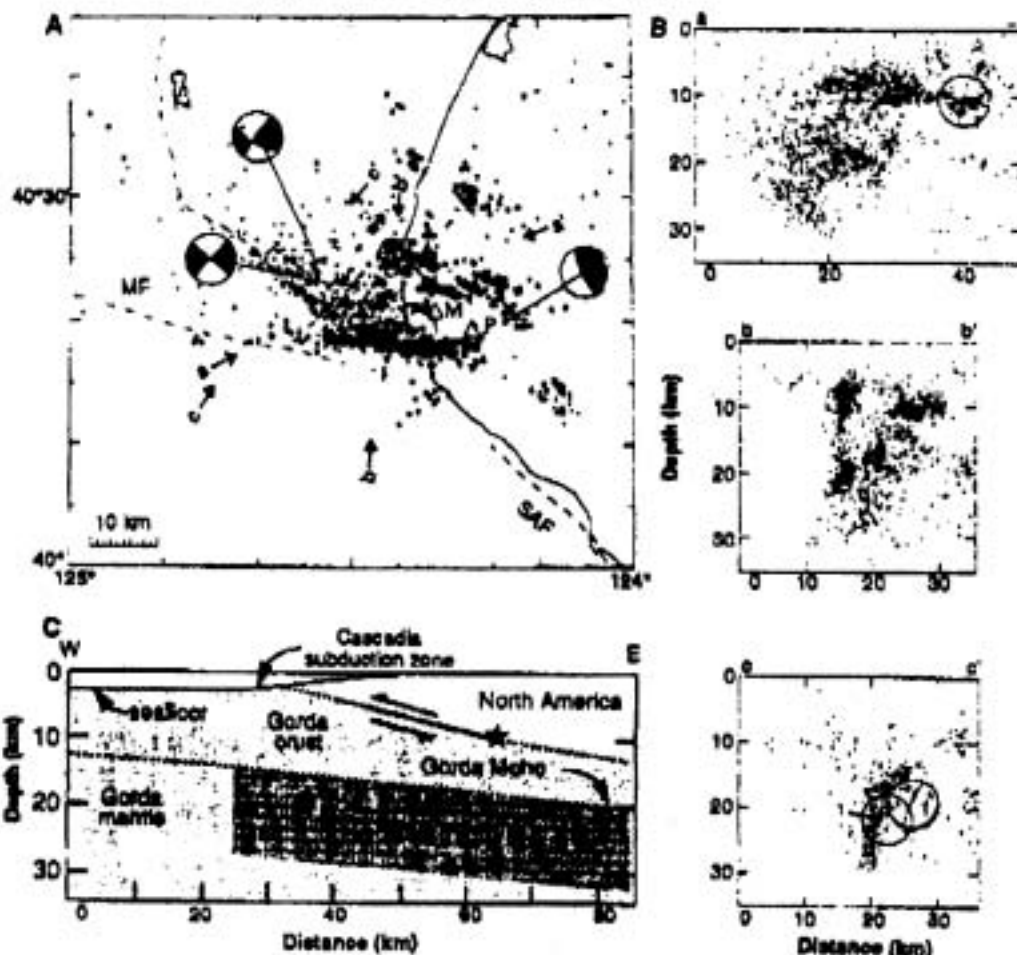

Fig. 3. (A) Focal mechanisms (lower hemisphere projections) of the main shock and two large aftershocks at their epicentral locations (compressional quadrants in black) and location of other aftershocks for 25 April 1992 to 30 September 1992 (open circles for foci <12 km deep and plus symbols for deeper foci). (B) Depth of earthquakes on cross sections aa' (perpendicular to main shock strike, width ± 20 km), bb' (perpendicular to Mendocino fault, width ± 20 km), and cc' (perpendicular to strike of $M_{8.8}$ aftershocks, width ± 9 km). Compressional quadrant marked by "T." (C) East-west cross section depicts location of main shock rupture plane (solid line), hypocenters (stars), and pre-main-shock seismicity with respect to plausible interpretation of Gorda-North America plate geometry.

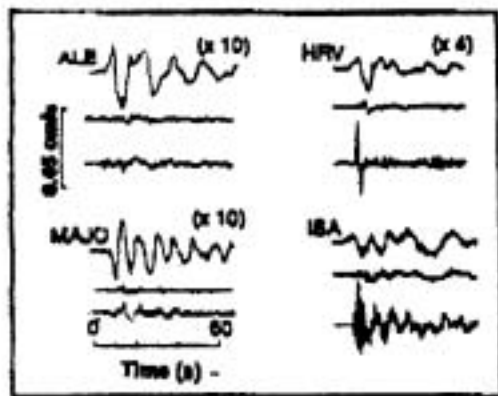

Fig. 4. Broad-band velocity records from four stations (ALE, epicentral distance $\Delta = 5188$ km, azimuth = 9° ; HRV: $\Delta = 4368$ km, azimuth = 69° ; MAJO: $\Delta = 8029$ km, azimuth = 308° ; ISA: $\Delta = 748$ km, azimuth = 132°) for the main shock (top trace) and the first (middle) and second (lower) aftershocks. The amplitudes of the seismograms at ALE, HRV, and MAJO are increased relative to ISA for display. The large amplitudes of the second aftershock relative to the other two events in the along-strike azimuth (ISA) is attributable to rupture directivity.

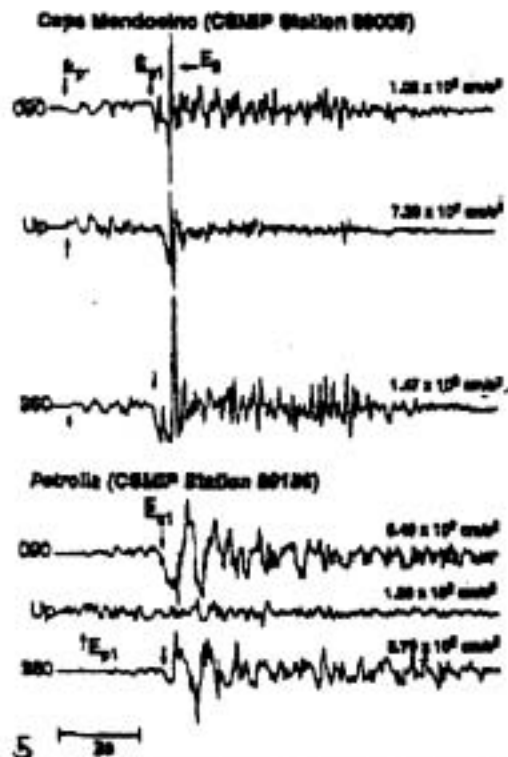

Fig. 5. Strong-motion recordings and peak accelerations on three axes from stations of the California Strong Motion Instrumentation Program (CSMIP) at Cape Mendocino and Petrolia (22). Discernible first-motion directions of the P and S waves for long-period event (E_{p1} and E_{s1}) are indicated, as is the large, high-frequency pulse at Cape Mendocino (E_3).

Table 1. Earthquake parameters.

| | Origin time* (UTC) | Latitude* (North) | Longitude* (West) | Depth* (km) | Centroid depth† (km) | M_L ‡ | M_S ‡ | Moment† (dyn-cm) | Strike† | Dip† | Rake† |
|----------------|----------------------|-------------------|-------------------|-------------|----------------------|---------|---------|-----------------------|---------|-------|--------|
| Main shock | 25 April 18:08:05.18 | 40°19.94' | 124°13.88' | 10.8 | 20 to 25 | 6.3 | 7.1 | 4.45×10^{28} | 349.7° | 13.0° | 105.6° |
| 1st Aftershock | 26 April 07:41:39.98 | 40°26.13' | 124°34.43' | 19.3 | 20 to 25 | 5.9 | 6.6 | 8.35×10^{26} | 122.3° | 78.0° | 78.2° |
| 2nd Aftershock | 26 April 11:18:25.82 | 40°23.38' | 124°34.30' | 21.7 | 30 to 35 | 6.5 | 6.8 | 1.29×10^{28} | 311.5° | 89.6° | 181.8° |

*Hypocentral location determined from the local seismic network of the U.S. Geological Survey (8). †From surface-wave inversion (18, 20) ‡N.E.I.C.P.D.E.

Fig. 6. Observed and predicted coseismic displacements for the Cape Mendocino main shock (epicenter located at star). The vectors are horizontal displacements relative to a site located at $41^\circ 19.20'N$, $123^\circ 52.92'W$. Observed displacements derived from GPS and Geodolite measurements; ellipses enclose regions of 95% confidence. Predicted displacements are from a model of uniform slip on the north-east-dipping rectangular fault plane, indicated by its surface projection. Rounded rectangles show vertical displacements measured by GPS that are greater than their standard deviations. Contours are elevation changes in millimeters predicted by the model. Abbreviations: CM, Cape Mendocino; MR, Mussel Rock; PG, Punta Gorda. (inset) Uplift measurements and their standard deviations from the die-off of marine organisms at coastal sites (open circles on map) projected along $N10^\circ W$.

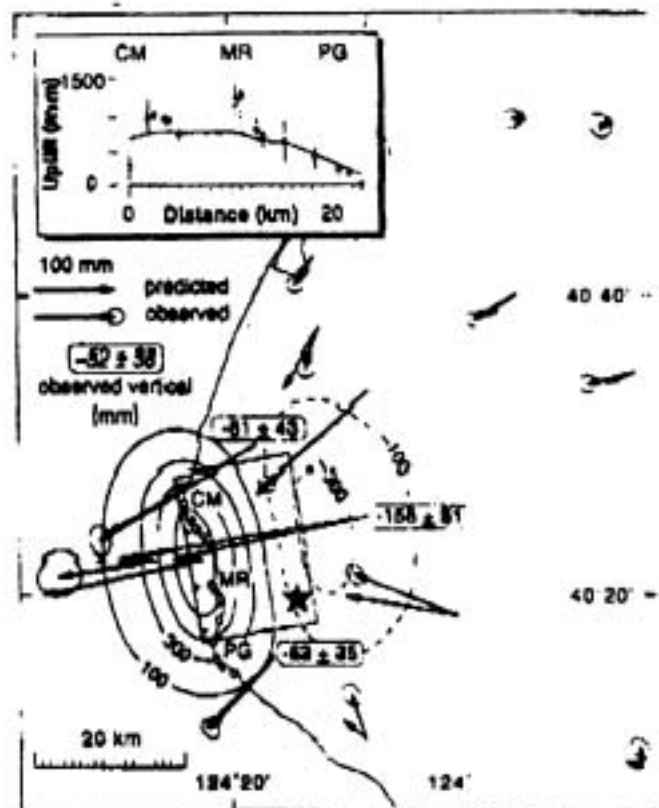

SCIENCE • VOL. 266 • 22 APRIL 1993

Table 2. Displacement model.

| Parameter | Value |
|-----------------------------|------------------------------|
| Width | 16 km |
| Length | 21.5 km |
| Depth to top edge | 6.3 km |
| Latitude origin* | 40°18.08'N |
| Longitude origin* | 124°11.80'W |
| Depth at epicenter location | 9.2 km |
| Moment† | 2.79×10^{28} dyn-cm |
| Strike/dip/rake | 350°/12.0°/94° |
| Slip | 2.7 m |

*Southwest corner of fault plane. †Assumes uniform rigidity of 3×10^{11} dyn/cm².

tudes at stations to the southeast, such as ISA. The difference in both Modified Mercalli intensity and broad-bank velocity records between the main shock and the second aftershock was probably enhanced by rupture propagation to the west during the main shock as inferred from the location of the hypocenter at the down-dip and of the rupture plane.

The strong ground motions of the main shock and two aftershocks were recorded on 14 instruments at epicentral distances of 5 to 130 km (Fig. 1), and the peak accelerations were some of the highest ever recorded (22). Recordings of the main shock at Petrolia and Cape Mendocino (Fig. 5) at epicentral distances of 5 and 10 km, respectively, have absolute time, facilitating the analysis of rupture evolution on the fault. Modeling of the large, long-period pulse that occurred 1 second after the main shock began (Fig. 5, E_{p1} and E_{s1}) with generalized ray theory indicates that this pulse originated from slip that occurred about 5 km up-dip from the hypocenter, beneath Petrolia. This result is consistent with the arrival times and polarities of the vertical P waves and horizontal S waves at both stations. In addition, the P-wave first motions were upward and northwestward at Cape Mendocino. These motions indicate that the source was southeast of the station. This source location is consistent with the west-southwest direction of rupture determined from teleseismic surface waves (19), although that study inferred that the rupture initiated offshore. A large,

high-frequency pulse (Fig. 5, E_2) followed the long-period pulse at Cape Mendocino and exceeded 1 g on both horizontal components. This pulse was not discernible at the neighboring Petrolia station; thus, it cannot be explained simply by source effects but may represent motions that were generated or amplified locally near the Cape Mendocino station. [H: Facts are that there is a reason that this cannot be explained by ordinary means. The thrust pulse was from the atmosphere which accounts for the "booms" heard just prior to and during the quakes themselves. This is why we are bothering to write all this—for the disbelievers, chelas, who continue to say we simply tell you things which do not make sense and spread fear and panic. Well, I don't see anyone in a panic enough to change very much of anything even in the daily routine when you have one of the most important scientific documents as a guideline—right here. Every fault is being "pulsed" intentionally and some of the areas such as THIS are so dangerous as to make even the angels faint of heart. You have like manipulations going on at the areas of concordance of the Whittier Narrows fault and the Tehachapi side of the Garlock Fault. The government covers the actions by giving you super-sonic SR-71s to watch. Well, readers, that "Tehachapi" bubble is holding and I want a few of you to "breathe" again, please.

The worst thing going on at present is

this same "pulsing" going on along the New Madrid Fault which can wipe-out the entire mid-section of your nation along that mighty Mississippi River! It is very definitely "breath-holding" time, readers. THIS paper is for you self-claimed "scientific minds" who totally denied this information when Soltec and I gave it to you at the time of those quakes in point. You are ALL on borrowed time because you CANNOT have such massive assault against the North American Plate without it slipping somewhere and it will be at a weak-score point and you end up with a "longer" Grand Canyon—like from Sea to Shining Sea!

Coseismic displacement. The elastic strain released by the main shock caused significant horizontal and vertical deformation in the epicentral region. The main shock elevated about 25 km of the coast from 3 km south of Punta Gorda to Cape Mendocino (Fig. 6). Many intertidal organisms inhabiting rocky reefs perished in the 3 weeks after the main shock. Maximum uplift was 140 plus-minus 20 cm (4'8") at Mussel Rock and 40 to 50 cm (1'6") at the northernmost reef at Cape Mendocino (23). The lack of rocky intertidal environments farther north precluded the precise location of the northern limit of the uplift, but several near-shore rocks located about 7 km north of Cape Mendocino showed no evidence of uplift.

Coseismic horizontal and vertical site displacements in a regional geodetic network (Fig. 6) were determined from Global Positioning System (GPS) surveys in 1989, 1991, and one month after the main shock. The relative positions of most sites near the epicenter were measured shortly after the 17 August 1991 Honeydew earthquake [body wave magnitude (M_b) 6.0], which occurred 6 km south of the Cape Mendocino epicenter. The coseismic displacements were determined by comparison of the 1989 to 1992 observations, except in the vicinity of the Honeydew event when the 1991 survey was referenced. All displacements were corrected for secular-strain accumulation estimated from Geodolite trilateration measurements made between 1981 and 1989. A site 13 km northeast of the epicenter had the largest measured coseismic displacement, moving 40 plus-minus 2 cm (1'4") to the west-southwest and subsiding 16 plus-minus 1 cm (6").

Our preferred uniform-slip fault mode (24), estimated from the coseismic site displacements and coastal uplift observations, indicates 2.7 m (9') of nearly pure thrust motion occurred on a gently dipping fault plane. This model, chosen from a suite of acceptable models (24), is consistent with the main-shock focal mechanism, the hypocenter location, and

Fig. 7. Tsunami measurements at tide-gauge stations along the coasts of California, Oregon, Hawaii, and Johnston Island. Tidal signal has been removed from all data except for Crescent City, California (nest) (note change of scale). Time of main shock is 0 hours. The vertical line marks the expected tsunami arrival time. Contour lines (dotted) represent ocean depth in kilometers, except for the single, unlabeled 500-m bathymetric contour line nearest the coast.

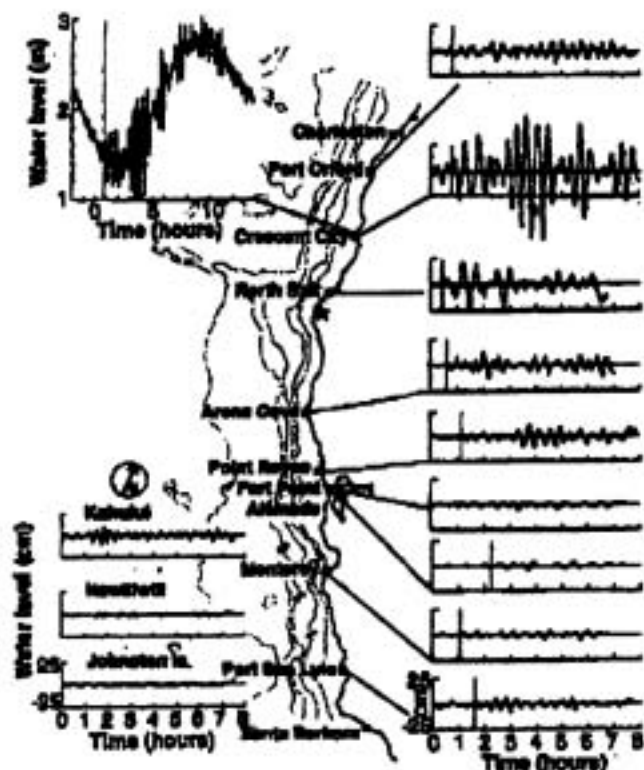

the distribution of aftershocks (Fig. 6 and Table 2). The range of geodetic moment inferred from the acceptable models is 2.5×10^{26} to 3.5×10^{27} dyn-cm, about 60% of the main-shock seismic moment (Table 1). The model predicts a maximum uplift along the coast that is consistent with but somewhat less than the observed uplift. More complex models that use nonuniform slip to describe the rupture may improve these estimates of uplift and geodetic moment.

[H: It is necessary that all of this data be included—this is a scientific paper and in the scientific community would not be acceptable otherwise—so, readers, bear with me. I honor these people for their work and they have studied this carefully—these numbers MEAN something. Now the next is that to which I ask you to closely attend. When you begin to recognize the dangers of Tsunami action you are getting to a very, very important point. This is going to UNDERSTATE THE ACTUAL HAPPENINGS WHEN YOU GET “THE BIG ONE” BUT YOU WILL NOTE THAT FROM NOW ON THE GEOLOGISTS IN CALIFORNIA WILL BE INTEGRATING THIS EQUATION WITH OTHER EARTHQUAKE ASSESSMENTS.]

Tsunami. The main shock generated a small tsunami recorded by gauges of sea level along the California, southern Oregon, and Hawaii coastlines (Fig. 7). The largest tsunami amplitudes were recorded at Crescent City, California, where two well defined packets of wave energy were recorded within the first 5 hours with maximum positive heights of 35 and 53 cm. Neither the precise arrival time nor the polarity of the first wave are clear because of the presence of background noise. However, the first packet of wave energy is consistent with the predicted travel time of 47 min. for a wave ray path that traversed deep water. The second wave packet probably represents coastal trapped waves, or edge waves, having much slower velocities and amplitudes that rapidly decrease with distance offshore. Because the tsunami arrival nearly coincided with low tide at Crescent City, the wave did not cause any damage. The tsunami at Crescent City had an 8-hour duration; wave heights reached a maximum 3 to 4 hours after the first arrival. Tide gauges also recorded the initial arrival and subsequent edge waves at North Spit (Eureka, California) (20 min. and 2.5 hours), Arena Cove (35 min. and 3.5 hours), and Point Reyes (63 min. and 3 hours).

MOTION ON THE PLATE BOUNDARY

Interplate main shock. The main-shock

fault projects to the sea floor within 5 km of the seaward edge of the Cascadia subduction zone (25) (Fig. 3), suggesting that the main shock ruptured the Gorda-North America plate boundary. In contrast, the upper boundary of the pre-main-shock seismicity, which is 7 km deeper than the main-shock rupture plane (figs. 2 and 3), projects to the surface about 85 km west of the Cascadia subduction zone and thus does not appear to define the plate boundary. The seismicity gap between the slip plane of the main shock and the pre-main-shock seismicity is about the same thickness as the Gorda crust and overlying accretionary sediments, as determined from refraction experiments 10 km east of the seaward edge of the subduction zone (26). The gap may reflect a ductile subducted Gorda crust, and the inception of seismicity at a depth of 17 km may reflect brittle behavior of the Gorda upper mantle (27). **[H: “Brittle” behavior is not good, readers; it indicates a shattering effect is possible which not only increases liquefaction but breaks much like an eggshell.]** Tabor and Smith (28) reached a similar conclusion from their observations of seismicity and velocity structure of the Juan de Fuca plate beneath the Olympic peninsula of Washington.

However, an inversion for the three-dimensional velocity structure of the region indicates that velocities typical of Gorda crust are evident at depths greater than 15 to 20 km (29). Moreover, modeling of thermal effects on the strength of the subducting oceanic lithosphere (30) suggests that the double seismic layers observed at depths of 20 and 30 km (Fig. 2) reflect, respectively, the brittle upper crust in the upper mantle of the Gorda plate; the intervening, relatively aseismic region would correspond to the ductile lower crust. Consequently, these studies suggest that the Cape Mendocino main shock was an **INTRA-PLATE** event in the North American Plate.

Whether the mainshock was an inter- or intra-plate event, the Cape Mendocino main shock clearly relieved strain resulting from the relative Gorda-North America plate motion. We note, however, that the main shock ruptured a region of the plate boundary that differs considerably from the boundary further north, as indicated by the change in the orientation from north-northwest to northwest (5), the relatively narrow width of the plate, the likely presence of subducted sediments in the region of main shock rupture, and its younger age (4). **[H: I would question that most carefully. I believe you will find that the stress was not relieved but, rather, was simply thrust more pressingly on the surrounding areas. This is ACTUALLY what happens with intra-plate events. Nothing about the entire series of quakes**

was NORMAL! NOTHING! This is a MAJOR trigger point and the devastation which can occur from such triggering at strategic locations such as this—are without ability to reckon.] Thus, this earthquake may not be typical of other Cascadia subduction zone earthquakes. **[H: Not by a long-shot! There was nothing typical about that quake and the next ones will be even more massively atypical.]**

Intraplate aftershocks. The location, depth, and focal mechanisms of the two large aftershocks indicate that they ruptured the Gorda plate. The seismic data indicate that right-lateral slip occurred on a vertical, northwest-oriented fault plane for at least the second event. For most earlier Gorda shocks, rupture occurred as left-lateral slip on a northeast-oriented plane, perhaps because this orientation may allow reactivation of normal faults formed at the Gorda spreading ridge (11). From a consideration of stress release, either orientation reduces north-south compressional stress and down-dip tension in the Gorda plate but ruptures of the northwest-oriented plane may have been favored because of the static stress changes imposed by the main shock and, perhaps, the first aftershock.

To test this hypothesis, we modeled the changes in static stress (31) imposed by the main shock (Table 2) on these vertical fault planes: the east-west-oriented Mendocino fault, the possible N-40°-E-oriented slip plane of the first large aftershock, and the N-50°-W-oriented fault of the second large Gorda aftershock. Large regions of the northwest-oriented fault and the Mendocino fault received an increase in right-lateral shear stress greater than 3 bars and equally large increases in normal extension resulting from the main shock. Both the increase in right-lateral shear and the increased extension would bring both of these right-lateral faults closer to failure under a Coulomb failure criterion for nonzero coefficients of friction. About 90% of the aftershocks within 4 km of the Mendocino fault and the northwest Gorda fault occur where the modeling predicts the stress changes should load these faults toward failure for coefficients of friction ranging from 0.0 to 0.75. Thus, static stress changes may have helped trigger aftershocks along these two faults.

The model also indicates that static stress changes induced by the main shock are slightly more favorable for failure on a northeast-striking, left-lateral fault plane in the location of the first large aftershock, primarily because of a decrease in normal stress. In consideration of the present relative hypocentral locations of the two large aftershocks, slip on the northeast-oriented plane of the first aftershock would have added minor left-lateral shear to the

northwest-oriented plane of the second aftershock but would have greatly decreased the normal stress on this plane. This scenario provides a simple mechanism in which the first aftershock helped trigger the second, similar to the scenario proposed for the Elmore Ranch-Superstition Hills pair of earthquakes (32).

Hazard implications. The Cape Mendocino earthquake sequence provided seismological evidence that the relative motion between the North America and Gorda plates results in significant thrust earthquakes. In addition to the large ground motions generated by such shocks, they can trigger equally hazardous aftershock sequences offshore in the Gorda plate and on the Gorda-Pacific plate boundary. This sequence illustrates how a shallow thrust even, such as the one of moment magnitude (M_w) 8.5 that is forecast for the entire Cascadia subduction zone (14), **could generate a tsunami of greater amplitude than the Cape Mendocino main shock. Not only would this tsunami inundate communities along much of the Pacific Northwest coast within minutes of the main shock, but it could persist for 8 hours at some locales. The 25 April 1992 main shock ruptured only a small part of the plate boundary and apparently did not trigger slip on any of the Holocene shallow thrust faults observed onshore in the triple junction region (17). Thus, given the high level of historical seismicity and the emerging picture of many active faults, the region is likely to continue experiencing significant seismicity.**

END QUOTING

This ends the article proper. There is a listing of 33 references and notes but the copy is so bad that I beg off asking Dharma to copy them. If you wish the information, please get a reprint from Dr. Oppenheimer. I do not wish to slight anyone's work but we are limited by time and space.

The point and reason for putting you through all this is so that anyone wishing to question these findings can do so—but MY reasoning is to tell you that you now have full evidence, scientifically reported, that should tell you that you are in for some massive upheavals in the western coastal areas. You cannot have great fracturing in one section and not have it radiate, actually, the full circle in displacement. If you have two gears turning against one another and one is slipped or triggered, the other is going to bend, bind or slip also. There are major critical vortices (hubs) which when adequately triggered will pull down the whole of the boundaries of the plates themselves with massive slippage. It is this bashing and underthrusting of the Pa-

cific under and northward of the North American Plate which will cause the greater uprising and upheaval. This in turn will trigger MAJOR tsunami and the "suction" of the underthrust can and probably will cause a sucking under of the coastal areas several miles inland—perhaps in the California area, the full width of the coast to the breaking San Andreas.

The prediction as stated in the article of the projected 8.5 quake which is forecast for the entire Cascadia subduction zone—is not correct for it will be in

excess of 10.0 as the stresses are now measured. Further, you will have a massive subduction slippage and rolling thrust which shall wash ashore at a great depth (or height depending on your speaking) and remain ashore before backwash for several hours.

All we can do, readers, is tell you to get ready for, when it begins, there will be splintering reaction all across the continent—much like the domino effect. May you hear and heed.

Good evening.

Nevada Corporations

WHO SHOULD INCORPORATE?

Many People say that "I'm just a family" or "I'm just a single person", "what does this have to do with me?" In Nevada, it ONLY REQUIRES ONE PERSON TO FORM THE CORPORATION, BE THE BOARD OF DIRECTORS, AND OFFICERS. You then gain all of the benefits of a Corporation; business wise and tax wise. Why do you think that the Government gives breaks to Corporations? Because most of the Government "Servants" are incorporated (in Nevada) and do business through those Corporations while their private lives remain private.

If you currently are in business and are not incorporated, you should be asking yourself why you have not incorporated yet. If you are not, then most of the reasoning will be wrong. Corporations give a business a tremendous amount of benefits.

If you own real estate in any state, a Nevada Corporation can protect that asset from you or you from it. If that property is held in a Corporation, your ownership of that asset is now hidden. This can be a real nice feeling for those of you that are privacy buffs and recognize the ever increasing law suits against individuals and their homes.

VALUE OF INCORPORATION

What the "little people" do not realize is that they can function in security and safety the same as the "big Corporate giants", but more effectively. People need to look around today and ask, "why is it that the more I work, the less I seem to make?" If you take a closer look, you will notice that those Corporations out there just seem to be getting bigger and bigger and seem to own and control everything. Well the fact is, they do! So why not do what the big boys are doing. They made the rules to suit themselves, why don't we take advantage of those same rules?

Another reason that Nevada is such a popular state to incorporate in is that NE-

VADA IS THE ONE STATE THAT DOES NOT HAVE AN AUTOMATIC EXCHANGE OF TAX FORMS WITH THE FEDERAL GOVERNMENT. Because Nevada does not have a State Corporate Income Tax, they don't require much information from their State's Corporations. This way they can get away with not sharing with the Feds. because they really don't have anything to share.

With a Corporation, what you do in your personal life does not rub off on what you do in your business life and vice versa. Your Corporation takes the heat off you just as long as you keep good, clean, and clear records that show activity that can be equated to Corporate business. No law says that you cannot make foolish decisions nor can they insist you "make money". Further, if they don't know who owns a Corporation (Nevada is the last state available where ownership is hidden) who can they pick on? All you need to do is keep simple, clean records and you are protected with your Nevada Safe Haven.

FOR MORE INFORMATION ABOUT NEVADA CORPORATIONS, CORPORATE RESIDENT AGENT SERVICES, & PRIVATE MAIL FORWARDING SERVICES CALL CORPORATE ADVISORS CORPORATION AT (702) 896-7002 OR WRITE TO THEM AT P O BOX 27740, LAS VEGAS, NV 89126. ASK FOR CORT CHRISTIE. FOR GENERAL BACKGROUND INFORMATION ABOUT THE VALUE OF NEVADA CORPORATIONS AND THE TRUTH BEHIND OUR MODERN ECONOMIC MALAISE, SEE THE PHOENIX JOURNALS: SPiral TO ECONOMIC DISASTER (#4) AND PRIVACY IN A FISH BOWL (#10). (See page 14 for description. See back page for ordering information).

*I am not bound to win but I am bound to be true.
I am not bound to succeed but I am bound to live up to what light I have.*

—Abraham Lincoln

Proof Of Our Messages Coming Soon

7/30/93 #1 HATONN

IS IT WORTH IT?

Is "WHAT" worth it? Freedom? Truth? Another's life? Another's soul? How about the price of Gold? How about your own life? What has meaning? Chelas, everything is relative and certainly, worthy of note if for no other reason than God gave you "thinking" capacity. What are the differences in special beliefs? I ask this for all of the many of you who are adrift in what to say when people question. Why? I see so many of you taking on the responsibility of seeing to it that somehow the world and all in it needs your input to SAVE it somehow. It is your responsibility to offer that which you have and believe—NO MORE! Others have come to believe that which they believe by prior training or information offered in some manner—no child was born with MAN-CONCLUDED DOCTRINES. EACH, HOWEVER, IS BORN WITH THE GOD WITHIN AND IF NO TAMPERING IS DONE THE LAWS OF GOD ARE SIMPLY PRESENT!

Here now, however, is where you are more gifted and released than are others, from the bindings of the "doctrines". There is nothing here which says "go forth and cram this down another's throat" and "save his soul". If you are doing that, my friends, your OWN soul is in a predicament. It will be enough if YOU live your life in such a way as to example that which YOU WOULD CAUSE THEM TO BE AND ACT. ACCEPT ONLY INTEGRITY FROM ONES IN YOUR EMPLOY BUT PLACE NO BINDINGS ON ANOTHER'S BELIEFS AND SOUL—MOST ESPECIALLY IF THEY BE OF INTEGRITY AND BASIC GOODNESS. Let us speak a moment of a "RAPTURE" as a for instance. What mean you by "rapture"? It is NOT in the Bible from which you seem to get your OTHER material for basing belief. Most people, however, do not THINK about it at all. It is accepted because some Biblical teacher said it is so. Certainly there WILL be some sort of saving vehicle as offered by God unto HIS people. The WRONG conception is that you can continue in all the worldly ways of misdeeds, immorality and still expect to get hoisted off in the twinkle of an eye unto some nice insecure clouds. The Master Christos (God) WILL BE IN THE SKY WHERE THE CLOUDS "ARE"—NOT SITTING OR STANDING ON THE VAPORS. But, beautiful chelas, be not in judgment

of WHO will make it and who will not. Some, such as some of your loved ones will be secured simply to relieve YOU of immediate load when your duty time is at hand. Stop concerning yourself with it. This is a very physical job in physical format. Yours is to do the best you can to offer material for consideration—you need push no further, lest you assume the very role which is left unto God as his OWN.

I come not to debate or argue—or save anyone's soul except by desire he would hear Truth and find his own way. This is WHY we have NO CHURCHES or "congregations".

Yes, you all need more discussion and sharing of spiritual recognitions—but that is not for us to thrust upon anyone. If ones wish or ask to come and share their own special truth—we shall most certainly welcome them. If their journey be toward God and not intent of locking into the human physical prison—we are indeed blessed. If theirs is to effort to pull you away into the multitude of approaches to that which is not of God—you must be fortified with Truth and KNOWING and you shall have no problem with anyone or anything you meet in confrontation of "reason".

We have one this day whom we hope will share with us. Is he really what he says he is—OF COURSE—FOR IF A MAN BELIEVES, THAT IS WHAT AND WHO HE IS! Will his prophecies be ALL? Unto all? No, no more than will MINE be unto all a conclusion of righteousness. I can and will tell you this much—God has sent the visions unto this one—and they match those which are flowing to others of God's vision receivers. Pay attention for what have you lost if you be prepared? NOTHING—but if these ones speak truth and are accurate, you ones don't have much longer to piddle around! You can see the signs of Revelation all about you—how foolish the child who can see the train bearing down upon him and defies his mother who also sees but cannot help in time—and stands there to be hit and slain. WE ARE MESSENGERS. That by definition means that WE BRING MESSAGES and, in this instance, FROM GOD according to HIS instructions and he who wants not to hear and see is granted his freedom. So be it.

By the way, you don't need to giggle and fidget in explaining "Who is Hatonn?". I am a writer, a selected journalist—a ghost writer, if you will. If this is easier for you than trying to explain something which

will be wrongly received by the other—do not stress yourself. It is the INFORMATION which is in point—not the writer! Simply say that you "work for" or "whatever", a paper and you "don't know"! If you "do" KNOW then I suggest you ask, "why do you want to know", or "do you find the information to be in error or what?" In light of that which we write—another good response is, "That is private because of the hazards of identification in view of the fact that we have all been threatened." If one does not accept this—why bother yourself further? Why introduce controversy? A person is welcome to partake or refuse—it is not your problem!!

Proof will be forthcoming soon enough and you will have laid your track-record. GOD will be recognized as will his HOSTS when the sequence is in order! Until then, let it go, release it and let us do that which WE ARE TO DO AND KNOW TO DO TO THE BEST OF OUR ABILITY AND RESPONSIBILITY. So Be it.

GOLD

I am, as always, getting bashed for not telling you by express mail or something that gold is taking off on the market. NO—I have told you ones from onset of our program that it would happen—BE PREPARED! If you are caught short—it is YOUR responsibility—NOT MINE! It may yet fall again but this time it looks like a substantial growth in the near-run with some fluctuation as ones stabilize. I am not your money adviser—I am your spiritual adviser! Remember?? If you have assets in anything on the MARKET—BEWARE!! THE CARDS ARE BEING PLACED ON THE TABLE AND IT IS INTENDED THAT THE CITIZENS OF THE NATIONS LOSE! The program as outlined is still available to you but we cannot speculate for "how long" because gold may well again get hard to acquire for any program, especially for collateral. At present E.J. has asked the metals people and the banks utilized to please secure some for probable users. YOU know who you are and NOW is the time to act! Like LAST week. If others get here in time, then you will certainly be given full explanation and access for as long as we can manage it. I repeat—WE ARE NOT YOUR MONEY DEALERS!!

DEMJANJUK

Don't let this travesty of justice prevail—that this man be barred from his rightful citizenship in America. Write, call, nag until this man is returned to Ohio to his family. I have something which is LOST to almost all of you and I ASK THAT YOU NOW POUND IT HOME! Just as in the World Wars, as example, the people of Austria were forced in military orders and

work forces over which they HAD NO CHOICES. DO YOU THINK IT DIFFERENT WITH A MAN LIKE JOHN DEMJANJUK? IF YOU DIDN'T WORK IN A CAMP IF PLACED THERE AND ORDERED TO DO SO—YOU WERE DEAD!

But, you ones again overlook the very THRUST OF THE JEWS against you. They demand that you not give him rights to return to America. HOW DARE ANY FOREIGN NATION OR PEOPLE DEMAND ANYTHING OF YOU CITIZENS OF AMERICA?? FURTHER, IF IT BE TRUE THAT JOHN CANNOT COME HOME BECAUSE HE "WORKED" IN A PRISON CAMP—WHAT OF EVERY JEW WITHIN THE CAMPS? EVERY JEW INCARCERATED EITHER WORKED OR PERISHED! THAT MEANS THAT EVERY JEW FROM ANY CAMP NOW IN AMERICA IS NOT ELIGIBLE TO LONGER BE A CITIZEN OF AMERICA AND MUST BE DEPORTED!! Write or FAX again—and tell your Congressmen and Traficant as much. ALL JEWS WHO SURVIVED THE CAMPS MUST BE DEPORTED FOR HAVING WORKED IN THE CAMPS AND MUST THEREFORE RELINQUISH AMERICAN CITIZENSHIP. IT MUST BE "STRIPPED" FROM THEM JUST AS IT WAS FROM DEMJANJUK! IT IS AMERICA ON TRIAL—NOT A MAN CALLED "JOHN"!

The man's citizenship was unlawfully stripped from him, HE WAS AND IS INNOCENT—AND THIS NATION MUST RETURN HIM TO THAT WHICH HE WAS AND HAD—**AND MAKE FULL AND TOTAL RESTITUTION FOR THE TIME IN JEOPARDY.**

STANDING ARMY

I have written about this but it appears the public does prefer to denounce me than read the publications which would cover such a statement as the G-7 voted to have a standing world army under the United Nations. You already have one, you just have missed it. The point now is to phase out all other armies, give this one full power and come down hard on the world citizenry. So you were fooled again? I'm sorry—I guess more people should get the CONTACT and read it ALL, along with the regularly printed JOURNALS. We really haven't MISSED VERY MUCH, chelas.

Right in the conference in Japan of the G-7 industrialized nations it was FORMALLY ENDORSED to create a United Nations army. This was an "economic summit" so what does this actually mean, sleepyheads? This is now Public Record! It was not, however, reported except by about three of us.

The G-7 nations (the United States, Britain, France, Canada, Italy, Germany and Japan) also took action to bring a third great region of the world, the "Pacific Community", into a POLITICAL REALITY!

The two other regions are the European

Community and the "American Community"—as the North Americana Free Trade Agreement is adopted and eventually extended throughout the Western Hemisphere.

Both actions are intended to bring about full compliance under the ruling world government, for full political convenience, over three major regions of the globe. **This was ORDERED BY THE SECRET BILDERBERG GROUP-TRILATERAL COMMISSION CABAL.** Both of these groups had set up and demanded this action during their annual meetings this year in Greece and in Washington. These ARE the Committee of 300 action arms.

There were over 3,000 journalists attending that Tokyo summit—do you REALLY THINK that ALL of them simply missed this little gem? It would be nice if some of you rock-throwers checked out your facts before hitting my staff!

THE BIBLE

Another request which I have and will begin to insist upon is that anyone who simply wants to debate ideas against my own regarding your Bible is going to find NO DEBATE. IF YOU HAVE STUDIED **ALL OF THE JOURNALS AND EVERY WORD OF THE CONTACT AS YOU CLAIM TO HAVE STUDIED THE BIBLE—EQUALLY—THEN, AND ONLY THEN, WILL I TAKE THE TIME OF ANY GROUP FOR YOUR PERSONAL ATTENTION.** We cover masses of information—actual mountains and yet ones come and want a two minute dissertation on the solutions of all mysteries of the Universe according to their own private determination. This is unacceptable for the answer has usually been given (often many times) prior to the question. It is a bit like your "Constitution", if you do not bother to KNOW your laws for which you petition rightful use—how can you expect to gain a goal—you don't know what it is. Do not denounce ME until you have studied everything I offer—for then and only then do you have RIGHT to opinion regarding me! This holds true for all things and all (every) individual person(s). Check it out—do you come to my meetings to hear my opinion or do you come to demand that others hear yours?? If it be the latter then I suggest you have your own meeting!

I most certainly AM NOT HERE to thrust off my directives onto YOU. There is WORKING ORDER and relationships here—nothing more. Your responsibility for self is not that which can be pushed onto another—NOT EVEN ME! I am your guide in some instances—NOT YOUR KEEPER. Be most careful that which you expect and especially that which you DO. I also ask that each look within and check out just exactly what do you tell others about this place and about me? You have no right to

misinform or suggest that I shall do anything for anyone—you only have right to say that which YOU WILL DO PERSONALLY! HOW MANY OF YOU ASSUME AND SUGGEST THAT SOMEHOW HATONN OR EKKERS OR SOME "OTHER" WILL DO THIS AND SO AND BE RESPONSIBLE OR HELP OR DO A THING? YOU CAN ONLY SAY THAT WHICH IS YOUR CAPABILITY AND RESPONSIBILITY PERSONALLY. IF YOU PERSONALLY CANNOT GUARANTEE A JOB, SAY, TO ANOTHER WISHING TO SETTLE IN THIS VALLEY—WHAT RIGHT HAVE YOU TO LOAD THAT RESPONSIBILITY ONTO ME OR ONTO EKKERS? WE ARE DOING OUR JOBS QUITE EFFECTIVELY, EVEN BRILLIANTLY—YOU MAY NOT VOLUNTEER ANYTHING IN OUR BEHALF FOR WE TOO HAVE NOTHING OF PHYSICAL VALUE TO OFFER AND YET IT HAS BEEN THUS SINCE ONSET OF OUR WRITING TASK.

I simply ask that you be personally responsible and as EACH is responsible—ALL shall become. As we have guests—we wish to share, nothing more and nothing less. It does not "sanction" nor does it indicate acceptance of anything more than exactly that—sharing. It might well surprise you to know that I would welcome Satan into my conference room to lecture you all he wishes—IN MY PRESENCE. Ah, herein lies the truth of it, however—IN MY PRESENCE! HE WILL NOT REMAIN FOR LONG IN MY PRESENCE AND NEVER AFTER I CHALLENGE HIM—UNTIL I DO SO HE IS ONLY ENTERTAINING! THESE ARE YOUR OPPORTUNITIES TO BECOME DISCERNING.

We have a meeting this noontime so I ask that this be cut short and let us get our other tasks under control in responsible fashion so that we do not leave important matters dangling. Thank you.

God never asks about our ability or inability--just about our availability.
--Anonymous

Those who fail in life often pursue the path of least persistence.
--Submitted by Tana Wood

When the pastor was asked if he had worked for the church all of his life, he said, "Not yet."
--Submitted by Denny J. Brake

The end never justifies the mean.
--Submitted by Don Marshall

From Guideposts Magazine
For subscriptions-
P.O. Box 856
Carmel, NY 10512-9970

Committee of 300

(Continued from Last Week)

7/30/93 #2 HATONN

Let us do another continuation of "Committee of 300" material. Again, I shall not take time to catch anyone UP. We had just begun, at our last writing on this subject, to speak about Aurellio Peccei and the New World Order. This material was assembled by Dr. John Coleman and the book can be obtained from him: Dr. John Coleman

World International Review, 2533 N. Carson St, Carson City, NV 89706.

Since we have a delay in the meeting originally scheduled for 12:00 we shall work on this for an hour or so as we are ALWAYS behind to great extent.

DR. AURELLIO PECCEI

[H: Taking up exactly where we left off:]

Peccei's call was answered by the most subversive "future planners" drawn from the United States, France, Sweden, Britain, Switzerland and Japan that could be mustered. During the period 1968-1972, the Club of Rome became a cohesive entity of new-science scientists, globalists, future planners and internationalists of every stripe. As one delegate put it, "We became Joseph's Coat of Many Colors." Peccei's book *Human Quality* formed the basis of the doctrine adopted by NATO's political wing.

The following is extracted from Dr. Peccei's book, *Human Quality*.

"For the first time since the first millennium was approached in Christendom, large masses of people are really in suspense about the impending advent of something unknown which could change their collective fate entirely.... Man does not know how to be a truly modern man.... Man invented the story of the Bad Dragon, but if ever there was a bad dragon, IT IS MAN HIMSELF... Here we have the human paradox: man trapped by his extraordinary capacity and achievements, as in a quicksand—the more he uses his power the more he needs it.

"We must never tire of repeating how foolish it is to equate the present profound pathological state and maladjustment of the entire human system to any cyclic crisis or passing circumstances. Since man has

opened Pandora's Box of new technologies, he has suffered uncontrolled human proliferation, the mania for growth, energy crises, actual or potential resource scarcities, degradation of environment, nuclear folly and a host of related afflictions."

This is identical to the program adopted by the much later fake "environmentalist" movement spawned by the same Club of Rome to blunt and turn back industrial development.

Broadly, the anticipated counter-program of the Club of Rome would cover inventing and disseminating "post industrialization" ideas in the United States, coupled with the spread of counterculture movements such as drugs, rock, sex, hedonism, satanism, witchcraft and "environmentalism". Tavistock Institute, Stanford Research Institute and the Institute for Social Relations, in fact the entire wide spectrum of research organizations in applied social psychiatry either had delegates on the board of the Club of Rome, or acted as advisors and played a guiding role in NATO's attempt to adopt the "Aquarian Conspiracy".

The name, New World Order, is seen as something developed as a consequence of the Gulf War in 1991, whereas the One World Government is recognized as being centuries old. The New World Order is not new, it has been around and developing under one or another guise for a very long time but it is perceived as a DEVELOPMENT OF THE FUTURE, which is not the case; the New World Order is PAST AND PRESENT. That is why I said earlier that the term One World Government is, or ought to be, preferred. Aurellio Peccei once confided in his close friend Alexander Haig that he felt like "Adam Weishaupt reincarnated". Peccei had much of Weishaupt's brilliant ability to organize and control the Illuminati of today, and it showed through in Peccei's control of NATO and formulating its policies on a global scale.

Peccei headed the Atlantic Institute's Economic Council for three decades while he was the Chief Executive Officer for Giovanni Agnelli's Fiat Motor Company. Agnelli, a member of an ancient Italian Black Nobility family of the same name, is one of the most important members of the Committee of 300. He played a leading role in development projects in the Soviet Union.

The Club of Rome is a conspiratorial umbrella organization, a marriage between Anglo-American financiers and the old Black Nobility families of Europe, particularly the so-called "nobility" of London, Venice and Genoa. The key to the successful control of the world is their ability to create and manage savage economic recessions and eventual depressions. The Committee of 300 looks to social convulsions on a global scale, followed by depressions, as a softening-up technique for bigger things to come, as its principal method of creating masses of people all over the world who will become its "welfare" recipients of the future.

The committee appears to base much of its important decisions affecting mankind on the philosophy of Polish aristocrat, Felix Dzerzinski, who regarded mankind as being slightly above the level of cattle. As a close friend of British intelligence agent Sydney Reilly (Reilly was actually Dzerzinski's controller during the Bolshevik Revolution's formative years), he often confided in Reilly during his drinking bouts. Dzerzinski was, of course, the beast who ran the Red Terror apparatus. He once told Reilly, while the two were on a drinking binge, that "Man is of no importance. Look at what happens when you starve him. He begins to eat his dead companions to stay alive. Man is only interested in his own survival. That is all that counts. All that Spinoza stuff is a lot of rubbish."

The Club of Rome has its own private intelligence agency and also "borrows" from David Rockefeller's INTERPOL. Every U.S. intelligence agency cooperates very closely with it, as does the KGB and the Mossad. The only agency that remained beyond its reach was the East-German intelligence service, the STASSI. The Club of Rome also has its own highly organized political and economic agencies. It was they who told President Reagan to retain the services of Paul Volcker, yet another important Committee of 300 member. Volcker stayed on as Federal Reserve Board chairman, notwithstanding the faithful promise of candidate Reagan that he would dismiss him as soon as he, Reagan, was elected.

[H: Yes indeed, THIS is the SAME Paul Volcker who George Green claims offered him the head of the financial committee for the candidacy of Carter! George claimed a lot of top-level

"friends". I would guess that they are even better friends now that he is efforting so diligently to silence Hatonn and other "patriots" and pull down those who would get the Truth to the citizens. And you think YOU have problems!]

The Club of Rome, after playing a key role in the Cuban Missile Crisis, attempted to sell its "crisis management" (the forerunner of FEMA) program to President Kennedy. Several Tavistock scientists went to see the President to explain what it meant, but the President rejected the advice they gave. The same year that Kennedy was murdered, Tavistock was back in Washington to talk with NASA. This time the talks were successful. Tavistock was given a contract by NASA to evaluate the effect of its coming space program on American public opinion.

The contract was farmed to the Stanford Research Institute and the Rand Corporation. **[H: Indeed, the "mother" of the Brookings Institute who sponsors the University of Science and Philosophy.]** Much of the material produced by Tavistock, Stanford and Rand never saw the light of day and remains sealed until now. Several Senate oversight committees and sub-committees I approached to obtain information told me they had "never heard of it", nor did they have the slightest idea where I might find what I was seeking. Such is the power and prestige of the Committee of 300.

In 1966 I was advised by my intelligence colleagues to approach Dr. Anatol Rappaport who had written a treatise in which the administration was said to be interested. It was a paper intended to bring an end to NASA's space program, which Rappaport said had outlived its usefulness. Rappaport was quite happy to give me a copy of his paper which, without going into fine detail, basically claimed the NASA's space program should be scrapped. NASA has too many scientists who were exerting a bad influence on America because they were always eager to lecture schools and university audiences on how rocketry worked, from construction to propulsion. Rappaport claimed that this would produce a generation of adults who would decide to become space scientists, only to find themselves "redundant" as no one would need their services **by the year 2000.**

No sooner had Rappaport's profiling report on NASA been presented to NATO by the Club of Rome, than the Committee of 300 demanded action. NATO-Club of Rome officials charged with urgent anti-NASA action were Harland Cleveland, Joseph Slater, Claiborne K. Pell, Walter J. Levy, George McGhee, William Watts, Robert Strausz-Hupe (U.S. ambassador to NATO) and Donald Lesh. In May 1967 a meeting was organized by the Scientific and Tech-

nological Committee of the North Atlantic Assembly and the Foreign Policy Research Institute. It was called "Conference on Transatlantic Imbalance and Collaboration" and it was held at Queen Elizabeth's palatial property in Deauville, France.

The basic purpose and intent of the conference at Deauville was to end U.S. technological and industrial progress. Out of the conference came two books, one of which is mentioned herein, Brzezinski's *Technotronic Era*. The other was written by conference chairman, Aurelio Peccei, entitled *The Chasm Ahead*. Peccei largely agreed with Brzezinski, but added that there would be chaos in a future world NOT RULED BY A ONE WORLD GOVERNMENT. In this regard, Peccei insisted that the Soviet Union must be offered "a convergence with NATO", such a convergence ending in an equal partnership in a New World Order with the United States. Both nations would be responsible for future "crisis management and global planning". The first Club of Rome's "global planning contract" went to the Massachusetts Institute of Technology (MIT), one of the premier Committee of 300's research institutes. Jay Forrester and Dennis Meadows were placed in charge of the project.

What was their report all about? It did not differ fundamentally from what Malthus and Von Hayek preached, namely the old question of not enough natural resources to go around. The Forrester-Meadows Report was a complete fraud. What it did not say was that man's proven inventive genius would in all likelihood work its way around "shortages". Fusion energy, the DEADLY enemy of the Committee of 300, could be applied to CREATING natural resources. A fusion torch could produce from one square mile of ordinary rock enough aluminum, for example, to fill our needs for 4 years.

Peccei never tired of preaching against the nation-state and how destructive they are for the progress of mankind. He called for "collective responsibility". Nationalism was a cancer on man was the theme of several important speeches delivered by Peccei. His close friend Ervin Lazlo produced a work in 1977 in a similar vein which was called "Goals of Mankind," a landmark study for the Club of Rome. The entire position paper was a vitriolic attack on industrial expansion and urban growth. Throughout these years, Kissinger, as the designated contact man, kept in close touch with Moscow on behalf of the RIIA. "Global modeling" papers were regularly shared with Kissinger's friends in the Kremlin. **[H: Indeed, do not forget that Henry Kissinger was a SOVIET AGENT! You can pick up a book by the same name from Criminal Politics, P.O. Box 37432, Cincinnati, OH 45222, 1-800-543-0486 (and tell them CONTACT referred you).**

The book is entitled: Henry Kissinger, Soviet Agent.]

With regard to the Third World, the Club of Rome's Harland Cleveland prepared a report which was the height of cynicism. At the time, Cleveland was United States Ambassador to NATO. Essentially, the paper said it would be up to Third World nations to decide among themselves which populations should be eliminated. As Peccei later wrote (based on the Cleveland Report): "Damaged by conflicting policies of three major countries and blocks, roughly patched up here and there, the existing international economic order is visibly coming apart at the seams.... The prospect of the necessity of the recourse to triage—deciding who must be saved—is a very grim one indeed. But, if lamentably, events should come to such a pass, the right to make such decisions cannot be left to just a few nations because it would lend themselves to ominous power over life of the world's hungry."

In this is found the committee policy of deliberately starving African nations to death, as evidenced in the sub-Sahara nations. This was cynicism at its worst, because the Committee of 300 had already abrogated the decisions of life and death unto itself, and Peccei knew it. He had previously so indicated in his book *Limits of Growth*. Peccei completely dismissed industrial and agricultural progress and in its place demanded that the world come under one coordinating council, to wit, the Club of Rome and its NATO institutions, in a One World Government.

Natural resources would have to be allocated under the auspices of global planning. Nation states could either accept Club of Rome domination or else survive by the law of the jungle and fight to survive. In its first "test case", Meadows and Forrester planned the 1973 Arab-Israeli War on behalf of the RIIA to sharply bring home to the world that natural resources like petroleum would in the future come under global planners' control, meaning of course, under the control of the Committee of 300.

Tavistock Institute called for a consultation with Peccei to which McGeorge Bundy, Homer Perlmutter and Dr. Alexander King were invited. From London Peccei traveled to the White House where he met with the President and his cabinet, followed by a visit to the State Department where he conferred with the Secretary of State, the State Department's intelligence service and State's Policy Planning Council. Thus, from the very beginning, the United States government was fully aware of the Committee of 300's plans for this country. That should answer the often asked question, "Why would our government allow the Club of Rome to operate in a subversive manner in the United States?"

Volcker's economic and monetary poli-

cies were a reflection of those of Sir Geoffrey Howe, Chancellor of the Exchequer and member of the Committee of 300. This serves to illustrate how Britain has controlled the United States, beginning from soon after the War of 1812, and continues to exercise control over this country through the policies of the Committee of 300.

What are the goals of the secret elite group, the inheritors of Illuminism (Moriah Conquering Wind), the Cult of Dionysius, the Cult of Isis, Catharism, Bogomilism? This elite group that also calls itself the OLYMPIANS (they truly believe they are equal in power and stature to the legendary gods of Olympus, who have, like Lucifer their god, set themselves above our true GOD) absolutely believe they have been charged with implementing the following by divine right:

1. A One World Government-New World Order with a unified church and monetary system under their direction. Not many people are aware that the One World Government began setting up its "church" in the 1920s/1930s, for they realized the need for a religious belief inherent in mankind to have an outlet and, therefore, set up a "church" body to channel that belief in the direction they desired.
2. The utter destruction of all national identity and national pride.
3. The destruction of religion and more especially the Christian religion, with the one exception, their own creation mentioned above.
4. Control of each and every person through means of mind control and what Brzezinski calls "technotronics" which would create human-like robots and a system of terror beside which Felix Dzerzinski's Red Terror will look like children at play.
5. An end to all industrialization and the production of nuclear generated electric power in what they call "the post-industrial zero-growth society". Exempted are the computer and service industries. United States industries that remain will be exported to countries such as Mexico where abundant slave labor is available. Unemployables in the wake of industrial destruction will either become opium-heroin and/or cocaine addicts, or become statistics in the elimination process we know today as Global 2000.
6. Legalization of drug and pornography.
7. Depopulation of large cities according to the trial run carried out by the Pol Pot regime in Cambodia. It is interesting to note that Pol Pot's genocidal plans were drawn up here in the United States by one of the Club of Rome's research foundations. It is also interesting that the Committee is presently seeking to

reinstate the Pol Pot butchers in Cambodia.

8. Suppression of all scientific development except for those deemed beneficial by the Committee. Especially targeted is nuclear energy for peaceful purposes. Particularly hated are the fusion experiments presently being scorned and ridiculed by the Committee and its jackals of the press. Development of the fusion torch would blow the Committee's conception of "limited natural resources" right out of the window. A fusion torch properly used could create unlimited untapped natural resources from the most ordinary substances. Fusion torch uses are legion and would benefit mankind in a manner which as is yet not even remotely comprehended by the public.

9. Cause by means of limited wars in the advanced countries, and by means of starvation and diseases in Third World countries, the death of 3 billion people by the year 2000, people they call "useless eaters." The Committee of 300 commissioned Cyrus Vance to write a paper on this subject of how best to bring about such genocide. The paper was produced under the title the *The Global 2000 Report* and was accepted by Edwin Muskie, then Secretary of State. Under the terms of the Global 2000 Report, the population of the United States is to be reduced by 100 million by the year 2050.

10. To weaken the moral fiber of the nation and to demoralize workers in the labor class by creating mass unemployment. As jobs dwindle due to the post industrial zero growth policies introduced by the Club of Rome, demoralized and discouraged workers will resort to alcohol and drugs. The youth of the land will be encouraged by means of rock music and drugs to rebel against the status quo, thus undermining and eventually destroying the family unit. In this regard The Committee of 300 commissioned Tavistock Institute to prepare a blueprint as to how this could be achieved. Tavistock directed Stanford Research to undertake the work under the direction of Professor Willis Harmon. This work later became known as *The Aquarian Conspiracy*.

11. To keep people everywhere from deciding their own destinies by means of one created crisis after another and then "managing" such crises. This will confuse and demoralize the population to the extent where faced with too many choices, apathy on a massive scale will result. In the case of the United States, an agency for crisis management is already in place. It is called the Federal Emergency Management Agency (FEMA), whose existence I first disclosed

in 1980. There will be more on FEMA as we proceed.

12. To introduce new cults and continue to boost those already functioning which includes rock "music" gangsters such as the filthy, degenerate Mick Jagger's "Rolling Stones" (a gangster group much favored by European Nobility) and all of the Tavistock-created "rock" groups which began with "The Beatles".

13. To continue to build up the cult of Christian fundamentalism begun by the **British East India Company's servant, Darby, which will be misused to strengthen the Zionist state of Israel through identifying with the Jews through the myth of "God's Chosen People" and by donating very substantial amounts of money to what they mistakenly believe is a religious cause in the furtherance of Christianity.**

14. To press for the spread of religious cults such as the Moslem Brotherhood, Moslem fundamentalism, the Sikhs, and to carry out experiments of the Jim Jones and "Son of Sam" type of murders. It is worth noting that the late Ayatollah Khomeini was a creation of British Intelligence Military Intelligence Division 6, commonly known as MI6, as I reported in my 1985 work, *What Really Happened in Iran*.

15. To export "religious liberation" ideas around the world so as to undermine all existing religions but more especially the Christian religion. This began with "Jesuit Liberation Theology" which brought about the downfall of the Somoza family rule in Nicaragua and which is today destroying El Salvador, now 25 years into a "civil war", Costa Rica and Honduras. One very active entity engaged in so-called liberation theology is the Communist oriented Mary Knoll Mission. This accounts for the extensive media attention to the murder of four of Mary Knoll's so-called nuns in El Salvador a few years ago. The four nuns were Communist subversive agents and their activities were widely documented by the government of El Salvador. The United States press and news media refused to give any space or coverage to the mass of documentation in possession of the Salvadorian government, documentation which proved what the Mary Knoll Mission nuns were doing in the country. Mary Knoll is in service in many countries, and played a leading role in bringing Communism to Rhodesia, Mozambique, Angola and South Africa.

16. To cause a total collapse of the world's economies and engender total political chaos.

17. To take control of all foreign and

domestic policies of the United States.
18. To give the fullest support to supranational institutions such as the United Nations (UN), the International Monetary Fund (IMF), the Bank of International Settlements (BIS), the World Court and, as far as possible, make local institutions of lesser effect by gradually phasing them out or bringing them under the mantle of the United Nations.

19. Penetrate and subvert all governments, and work from within them to destroy the sovereign integrity of nations represented by them.

20. Organize a world-wide terrorist apparatus and negotiate with terrorists whenever terrorist activities take place. It will be recalled that it was Bettino Craxi who persuaded the Italian and U.S. governments to negotiate with the Red Brigades kidnapers of Prime Minister Moro and General Dozier. As an aside, General Dozier is under orders not to talk about what happened to him. Should he break that silence, he will no doubt be made "a horrible example of" in the manner in which Kissinger dealt with Aldo Moro, Ali Bhutto and General Zia ul Haq.

21. Take control of education in America with the intent and purpose of utterly and completely destroying it.

Much of these goals, which I first enumerated in 1969, have since been achieved or are well on their way to being achieved. Of special interest in the Committee of 300 program is the core of their economic policy, which is largely based on the teachings of Malthus, the son of an English country parson who was pushed to prominence by the British East India Company upon which the Committee of 300 is modeled.

TO BE CONTINUED.

I believe this is all we have time for at this sitting so we will plan to take up here with "Malthus and the British East India Company." Thank you.

I am continually asked by ones who become aware of speaking engagements of Dr. Coleman, such as soon planned in Las Vegas, as to whether or not you "should attend". Of course, he has compiled some of the most important information you shall ever have presented to you. You do not have to go march off with the British Intelligence—just pay attention and support his work offered in truth of your circumstances. I supported the man while he wrote the book and I support the work now—men are subject to error—his "judgment" will be that which is between himself and God—not my dallying.

Salu.

Contact: Free Press With Some Information

7/31/93 #1 HATONN

GUTS, GRIT, GLITZ OR SIMPLY,
GOD?

Two major questions come back to me on a regular basis: 1. How does this bunch have the guts to publish such dangerous information? and 2. How could I put a person in such jeopardy as to ask Dharma to write this incredibly dangerous information? To both: WE SERVE GOD CREATOR! We know the task at hand, be it fulfilled positively or in a most costly "everything" manner; it must be done if Light and balance is to be returned to this wondrous planet and the creations of God.

When all is said and done, we or anyone else, who speaks out does so realizing that the audience is very limited. This is because of the controlled

media. Therefore, if not WE—WHO? There are many within your system who give it "all" every day of their lives and openly share EVERYTHING THEY HAVE—I often speak of them and offer any assistance I can even if it be to simply "pass it on"—for that is what the paper and JOURNALS are about—FREE PRESS WITH SOME INFORMATION! Where else, save one or two hidden pockets of press, can you get anything of truth—even about persons who present themselves as your informers and leaders? Of course I have a MAJOR example in hand, along with a stack of others well over a foot in depth—waiting their turn at the priority wheel. It is all but impossible to sift through and prioritize the information for it all becomes so critical according to the related sector in point, i.e., politics, military, economics, famine, flood, etc.

HELP Renick, Demjanjuk & Others

7/31/93 #1 HATONN

GUNTHER RUSSBACHER AND
RAY RENICK

I am humbly grateful to you readers for having kept your support flowing to these people. There are others, of course, also, but these two have personally been so flooded with fond letters and support that they cannot find a way to thank you properly. As I say, there are others; Weaver, Harris, Webb, Campbell—and on and on. Because there are so many it is even more appreciated by me that you have never failed to respond to my requests to remember our imprisoned compatriots—held helpless in places of prisons and detention.

Just as YOU have, through your efforts through our own people, brought Justice for Demjanjuk in Israel—so too can your support and ceaseless demands for his U.S. Justice cause the power-brokers to bring this man HOME. He is not wanted in the U.S.

because the criminal actions which sent him to Israel illegally will be shown in the Light of Day. MAKE IT SO, READERS, PLEASE, PLEASE, MAKE IT SO!

I take just a minute to thank you readers in the behalf of the ones you have attended for they are touched, yea, changed, by your love and compassion. They are touched by your lack of "JUDGMENT" of them and your unlimited faith that God, through your own faith, will see to HIS people. In that, dear friends, I THANK YOU.

These men are allowed very little with which to work in the line of paper, pens, stamps and thus and so. They simply cannot reply to every one—they would not be allowed to do so and therefore if it seems your messages are a "one way street". Please know—it is not—for when you are in prison the "rules" are the master. To stop the "perchance" of communications on a large scale—stamps are forbidden bounty. I would say, however, and I think I have not mentioned this

before—it is required that each prisoner be allowed an account at the commissary for personal needs, stamps and thus and so. It is NOT as simple as just sending along money but, in a case or two, our people have asked for deposit slips and a small amount of money can be deposited into a prisoner's account. That resource, for instance, has allowed Gunther to file legal cases and this last one filed may cause the authorities to grant him a hearing. I hate to load another block on E.J.'s back but if you want to send a gift of funds to any of these people—send it, with a note, of instructions—to E.J. and he can get someone to place it properly.

Remember that the master said to his people, "When I was hungry you fed me, when I was sick you attended me and when I was in prison ye visited me." And a disciple spoke up and said, "But Lord, I did not visit you!" The Master replied, "Aye, but when ye do these things unto the least of mine—so too have ye done it unto me!" In behalf of GOD—"I" THANK YOU, PRECIOUS FRIENDS!

Ray especially needs your "personal" loving words of support. He feels that he is not accepted for whatever he may have done "wrong" by temper, failure of proper action—whatever. No, what IS—IS! God does NOT go about SNATCHING anyone from ANYTHING. The problems must be handled properly according to the Law in that each success under the law is success for ALL. Ray believes "me" to be angry with him—NO! I love him greatly and honor him for the truth he has brought in the face of such adversity. Frustrations, anticipation, helplessness and inability to "buck this bastardized system" is stress beyond most one's belief of fact. Then, you get incarcerated and the brainwashing, the torment and the actual "pulsing" sets in in real determination to undo the "victim". All I can say to anyone and to Ray in particular—"do not effort to outthink God and keep the Light shield around you, son. We need no dead or damaged 'martyrs'—we need ones willing to LIVE FOR RIGHTEOUS CAUSE OF FREEDOM AND TRUTH. Feel forsaken if you will—but I suggest you get up off your downside and take the cards and letters and RE-READ THEM OVER AND OVER AGAIN UNTIL LIGHT ENTERS WITHIN THE DARKNESS AND DESPAIR. Does it help? ALWAYS!"

Our people have suffered greatly at the turning of events and funds are all but zilch—so they must do that which they can until ladders can be increased. That means that many fires already aflame MUST be attended as deadlines MUST BE MET in their proper sequences. Ones on the outside have to also have attention to needs and that must ALWAYS be attended as in "business attention" with REASON for helping beyond that of friendship—so the books are valid reflections in ALL cases. Just as we can shift some small funds through expenses for material through

the CONTACT, so too can help be gleaned from that resource. However, at present the funding is not there—so, in the interim, let us build audience. We will rerun the SLO material and meanwhile, Ray, learn everything you can about the LAW and continue to WRITE—CONTACT will run it—for just as long as our people can keep at it!

When I speak of "we" or "I" in "doing something or other"—please understand the facts in play—"I" or "we" don't do anything—YOU ONES ARE THE HANDS AND FEET OF GOD! I AM THE VOICE IN THE "CROW'S NEST"!

To our beloved friends caught already in the spider's trap (Literally as Gunther was

just, within the past two days, bitten badly by a Recluse Spider and is suffering greatly from the venom and the treatment.), when it seems the adversary can't do another thing miserable TO YOU—he finds something, doesn't he? Probably the most gracious and wonderful gift you could give, say, to Gunther, is to help a bit as you can, toward fees, phone bills, etc., to Rayelan that they "get through this". Rael is in bankruptcy and even that is NOT FREE—YOU ONES CAN'T EVEN LOSE EVERYTHING YOU HAVE—WITHOUT MAJOR EXPENSE! KEEP YOUR SENSE OF HUMOR AND REMEMBER "THE PLAY"—IT IS A PLAY AND YOU ARE THE PLAYERS—DO NOT SUCCUMB TO THE ILLUSION!

George Green Continues His Money Games

7/31/93 #1 HATONN

MONEY AND BIG GAMES

The people here are limited as to what they can do but realize that Gene Dixon has never stopped his work with the CLC—not for a minute. He now spends the majority of this time batching it in Tehachapi where he can have the help of Karen and Mitch (and others here) to attend all these cases under way and getting them ready for the specific attorneys who will "do" the hearings. This is a MASSIVE job and until we can get the myriads of pieces of litigation off our backs regarding Green, et al, we are swamped. However, the enemy never seems to default in annoyances. George Green is now calling ones here and there and telling them that three or four new attorneys are going to be coming against Ekkers and other such interesting "stuff". I

am irritated with it, George. I know that there is no longer the amount of money in gold as there WAS—George has been stealthing the commodities in his control into Puerto Rico (San Juan) through Raul Hernandez. I would think HIS OWN people would be about sick of his "arrangements". I would further guess that his REGULAR bits of income "for services" to the "big boys" is also about dried up or in the process of being shut-down. The big boys do not play nicely when you tromp on their toes or become a bigger focus and danger of uncovering than the garnerings are worth. Whether YOU ONES BELIEVE IN MY PRESENCE OR NOT—THE BIG BOYS KNOW EXACTLY WHO I AM AND WHAT I CAN DO IF I SO CHOOSE! SO BE IT. So we thank you all and give our grateful appreciation to that which you do with the pen for in the ending IT SHALL BE mightier than the sword. Now, back to the current daily tid-bits of input.

ZIGGY



ZIGGY



Lindbergh Kidnapping Tied To Schwarzkopf

7/31/93 #1 HATONN

GEN. NORMAN SCHWARTZKOPF

Just as, if we didn't tell you differently, you would think Alan Dershowitz is a loyal Constitutionalist, there are many others who SEEM to be something they ARE NOT. Dershowitz is always SEEN in every prominent "case" that happens and yet—he didn't do anything good for Tyson, Helmsley, etc. He is a self-proclaimed "Israel First" worker and has gone further so as to publicly state: **That America will be the new Israel as the pro-Israelites take over the government.** Another in the field of politics and economics is one called Larry Abraham. Gary Allen wrote a book *None Dare Call it Conspiracy*—it was actually mostly the work of Eustace Mullins and was a top level publication and Mullins was in the circle during the writing, etc. Somehow that book became to be recognized as Larry Abraham's property and work. Recently Abraham wrote another called *Call it Conspiracy*. Same thing—reworked. Abraham is a member of and did in fact set-up the "Phoenix Club" of newsletter publishers and has done totally unscrupulous things and orchestrated immoral, if not totally illegal, organizations operating with Schultz in Monaco. All under the guise of patriotism and *Constitutional "rights"*.

Now comes a thrust to run SCHWARTZKOPF for president of the U.S.A. What do YOU REALLY KNOW ABOUT THIS MAN? If "I" told you—would you believe me? Did I think him a "good man"? NO! Did I think him a "good general"? YES, for he was bloodthirsty enough to win a war if it cost every one of his men, and the enemy, their lives. I DO NOT SANCTION WAR OR VIOLENCE!—PERIOD!!

I don't have to do an "introduction" to this article but I want to again recognize Eustace Mullins (whom I honor greatly in all his work) for researching and presenting FACTUAL TRUTH that you might evaluate circumstances and persons of prominence who can impact you mightily.

As you read this, however, please keep in mind the little group trying to get ALL of your personal information—COSMOS! Remember, they stressed that working with them were several people of importance (to sell you on their authenticity and good intentions), like Janet Reno AND NORMAN SCHWARTZKOPF. Stop paying attention

and you are goners.

The following explains itself so I ask that Dharma simply present it as is:

QUOTE:

TIP: GEN. NORMAN SCHWARTZKOPF

(TIP—*Tare Identification Program*—is a regular feature of *Kingdom Chronicle*. Its purpose is in keeping with the parable of the wheat and the tares given by our Master in Matthew 13.)

An item of interest came across our desk from the July 1992 issue of *Instauration* magazine: "Switzerland. A maverick Swiss Jew, Niklaus Meinberg, wrote a lengthy article for a rural Swiss newspaper which was reprinted in Zurich *Tagensanzeiger*, a popular daily. Meinberg claimed that **General Norman SCHWARTZKOPF of Gulf War fame, has an IQ of 170 and a Jewish mother.**"

His ancestry is not surprising in view of the research done by our compatriot, Mr. Eustace Mullins. In an article first written in the 1970's, and reprinted in 1988 by the *CDL Report*, (P.O. Box 449, Arabi, LA 70032), Mr. Mullins unmasked Schwartzkopf's Jewish ancestry... Except that Mr. Mullins was talking about "Stormin' Norman's" father, Col. H. Norman Schwartzkopf, Sr. And therein hangs an amazing story, dug out by Mr. Mullins, and from which we excerpt briefly below. [H: I would ask you to recall that "Norman" was the beloved favorite of the Jewish community and the Jewish Lobbies—not to mention that he was special speaker with overwhelming reception in the Jewish leagues and especially in Florida in the Jewish retirement and vacation communities.]

Many of our readers are no doubt aware of the very highly publicized crime, the 1932 kidnapping and murder of the toddler son of Charles Lindbergh, Jr., the famous aviator. A poor German immigrant by the name of Bruno Richard Hauptmann was charged, convicted and executed in the electric chair in 1936. The truth is, however, that Hauptmann had been framed by conspiracy of the prosecutor, the defense attorney, and Col. Norman SCHWARTZKOPF. The prosecutor was the Attorney General of New Jersey, the Jew David Wilentz.

Quoting from the article by Eustace Mullins: "Governor Hoffman of New Jersey later wrote in *Liberty Magazine* that J.

Edgar Hoover informed him that he and the FBI had formally withdrawn from the case on October 10, 1934. This was three weeks after Hauptmann's arrest, when Hoover's agents reported to him that Wilentz and his chief co-conspirator, the Jew Col. H. Norman SCHWARTZKOPF, head of the New Jersey State Police (SCHWARTZKOPF means "blackhead" in German) were concocting a completely phony case against Hauptmann....

"During the Hauptmann trial in New Jersey, Wilentz became fearful that the parade of perjured witnesses he and SCHWARTZKOPF had suborned, as well as the clumsily manufactured evidence against Hauptmann, was having little effect on the jury....

"To understand Wilentz' predicament, we should realize that he was a typical Jewish fraud and loudmouth. Although he was prosecuting the most publicized case in American history, Wilentz had never before tried a criminal case of any kind! Like most Jewish officials, he had not been elected to the office of Attorney General of the State of New Jersey, but had been appointed by Gov. Harry Moore as a political payoff after he had persuaded a number of Jews to switch their votes! If he could get a conviction against Hauptmann, he was assured he would become the first Jewish governor of New Jersey, and perhaps follow Woodrow Wilson's example in moving from that office into the White House. [Editor's note: Some investigators now believe that Wilson himself was Jewish, his real name having been Wolfsohn.]

"Since he had nothing to connect Hauptmann with the kidnapping and murder of the Lindbergh child but the possession of ransom bills, he and his fellow Jew, SCHWARTZKOPF, enlisted the state police in manufacturing a phony ladder and other evidence, and rounding up a group of perjured witnesses who would place Hauptmann at the scene of the crime." [H: Remember the Protocols? "15: If one of our people should unhappily fall into the hands of justice amongst the Christians, we must rush to help him; find as many witness as he needs to save him from his judges—UNTIL WE BECOME JUDGES OURSELVES!"]

"Because more than a dozen persons were involved in Wilentz' conspiracy, it was inevitable that J. Edgar Hoover and other officials would be warned of what Wilentz was doing. It was even more imperative that Wilentz convict Hauptmann in order to protect the real murderers, the Jews who actually kidnapped and ritually murdered the baby." [H: Chelas, we are talking about one of the most notable "babies" in the history of kidnapping and we are talking about a type of RITUAL MURDER.] "As a Jew, it was his duty to his tribe not only to erase all leads to the true killers, but also to prevent the public from learning any details of the nature of the crime, **A Jewish**

ritual-murder."

What about Hauptmann's defense attorney? Hauptmann was a virtually penniless immigrant. Enter newspaper publisher William Randolph Hearst. Hearst put up a \$300,000 fee to hire Big Ed Reilly of Brooklyn, a defense attorney notorious for getting numerous mobsters acquitted of murder charges. Again, we quote Mr. Mullins:

"It was well known that Hearst wanted a conviction. [What better way to insure that outcome than to pay off the 'defense' attorney?—Ed.] He was haunted by the fear that one of his children would be kidnapped, with a probable demand for a million dollar ransom, which he would have difficulty in paying. He had already relinquished control of the Hearst newspaper to a Jew, Richard Berlin. Few people knew that the Hearsts themselves were Jewish, the original name having been 'Hirsch'. This fact gave further

dimension to Hearst's interest in the case. He had forbidden any reporter to ever mention the words 'Jewish ritual murder' in any story. Thus he had a common bond with Wilentz in seeing Hauptmann convicted." (Ironically, in the 1970's, Hearst's granddaughter, Patty Hearst, became the second most famous kidnap victim in American history.)

The record shows that Charles Lindbergh, Jr., cooperated with the prosecution in convicting Hauptmann. Why?! Mullins suggests that Lindbergh, Jr. did not have the backbone his father had. Mullins' research presents a most plausible explanation which is buttressed by numerous historical facts. In summary, the murder of the Lindbergh baby was primarily revenge against the baby's grandpa, Congressman Charles Lindbergh, Sr., one of the most vocal and powerful opponents of the Jewish international bankers' Federal Reserve System! ...a private money

monopoly which has now completely enslaved the American people—and most do not even realize they are enslaved.

Thus, we have learned that the roly-poly man, whom the media portrayed as the "grandpa-next-door" in the general's uniform, the man who "brilliantly" masterminded the defeat of the "fourth most powerful military machine in the world", (Did you believe that Madison Avenue hype?) ...a man who is now earning five-figure fees on the lecture circuit while his autobiography is helped to the best-seller lists by the Jewish-controlled media, is none other than another wolf in sheep's clothing! Gen. H. Norman SCHWARTZKOPF is another Tare among the Wheat! Watch out for those angel-reapers of Matthew 13, General!

END QUOTING

The ADL And The "Iron Curtain Over America"

7/31/93 #1 HATONN

BOOK: *IRON CURTAIN
OVER AMERICA*

There is another book come into my attention which *probably* is "right on target" judging from the amount and kind of resistance it is receiving. Not even having monitored it I note that if the Anti-Defamation League is "after the author" and distributors—it must be valid. The ADL is actually from British Intelligence but they have done just about all they could (and finally got Green to do it) to shut down our work and the JOURNALS. The purposes were certainly different but the end result the same—only the JOURNALS still sit in a warehouse in Nevada. I think, however, not for much longer. And, moreover, we feel that the value has so depreciated that Mr. Green will STILL owe the full amount of his note to the Institute. Our people plan to demand a public auction and so far—no takers. No one wants to pay for anything TWICE! There is a scrap-paper dealer in Las Vegas who says he would move them for the scrap if he could "break-even" on the trip from Carson City to L.V. Encouraging? No, but factual—so it seems. It would appear to me that George Green must enjoy pounding nails in his own

soul's coffin. Would it not seem wiser in the "long" haul to give those JOURNALS back to the writer and the INSTITUTE to whom they were given now that he has damaged all beyond recovery financially? It is rarely worthwhile to seek REVENGE against God for your perceived misadventures constructed by self. The term "rare" gives far too many points to the silly revenger. Already, there will never again be "pleasure" and "joy" in ANYTHING the man undertakes to do or have—is the pittance of GOLD worthy of the price? Even if you get

I would like to give you a simple ad write-up about the book which doesn't even give market information but I think it will set the stage for your understanding of the "letters" which we will also share immediately following.

Lt. Gen. George E. Stratemeyer, USAF (ret.) says: "I congratulate you on your book and the service you have performed for our country. If my health would permit it I would go on a continuous lecture tour gratis and preach your book and recommendations. My *Iron Curtain Over America* will be on loan continuously and I intend to recommend its reading in every letter I write."

Lt. Gen. Edward M. Almond, USA (ret.) says: "It is an inspiration to me to find an

author with the courage and energy to research and to insure the publication of such information as you have assembled in order that the poorly informed average American may know wherein the real threats in our country lurk. Your book is a magnificent contribution to those who would preserve our American ideals."

Vice Admiral T. G. W. Settle, U.S.N. (ret.) says: "*The Iron Curtain Over America* is a most pertinent and excellently presented treatise on the 'cancer' in our national set-up.

"I hope this book has had, and will have, the widest possible dissemination, particularly to our leaders—in Washington, and in industry and the press—and that our leaders who are 'uncontaminated' will have their serious attention engaged by it."

Lt. General P.A. Del Valle, USMC (ret.) says: "I am impelled to write to you to express my admiration of your great service for the nation in writing this truly magnificent book. No American who has taken the oath of allegiance can afford to miss it, and I heartily recommend it as the honest and courageous dispeller of the fog of propaganda in which most minds seem to dwell."

Senator William A. Langer, former Chairman, Judiciary Committee: "I think it ought

to be compulsory reading in every public school in America."

Senator Pat McCarran, former Chairman, Judiciary Committee: "A fine book."

Hedda Hopper, syndicated columnist: "It's the most revealing and frightening book that has come across my desk in ages."

J.M. Hazlitt, syndicated columnist: "The most startling, challenging, alarming writing of the past fifty years."

WHO IS THE AUTHOR?

JOHN BEATY, author and former professor, Southern Methodist University, Dallas, Texas, is a veteran of World War I and served nearly five years in World War II with the War Department General Staff. He wrote military studies, edited the daily intelligence summary, and headed several important sections in the Military Intelligence Service.

[H: Dharma knew this was coming—sorry, chela. I ask that a copy be acquired and, indeed, if the author or his representative is amenable—we will run excerpts of the material—and then you need to support this kind of daring writer. Can you realize, readers, that YOU, through this conduit and this CONTACT, are made privy to the most desperately HIDDEN information on your planet? We are willing to do this tremendous work if you are willing to hang in there and get informed and support the jeopardized Americans and world leaders efforting to bring sanity back into your lives. This one, however, is going to hit you hard and you will HAVE TO KNOW that the recent reminders of the Soviets and war IS ON ITS WAY! Gird up your courage and open your minds for the curtain has actually "fallen". God bless you. So, IS THIS BOOK GOING TO OFFER NEW INFORMATION? NO! BUT IT WILL CONFIRM THAT WHICH YOU HAVE ALREADY BEEN SHOWN AND GIVEN!]

QUOTE:

Despite tremendous pressures *The Iron Curtain Over America* has increased in circulation and influence through individuals and groups who have accepted the responsibility and challenge of spreading the truth.

The forces of suppression and censorship exert strong influence to deny the established channels of book and news distribution to documented books which expose the origin and true nature of COMMUNISM. Ready access is provided for left-wing (socialist) literature and sex novels and pornography, which undermine the morals and morale of youth and adults alike.

The COMMUNIST METHOD of attack and seizure of a nation is through infiltration and control of the public information and influence media (radio, TV and press) and its distribution—imposing a virtual censorship on its citizens. **[H: Goodness, nothing NEW at all—but, chelas, you have to GET IT UNDERSTOOD YOURSELF—FROM EVERY AVAILABLE RESOURCE—THEN you can act in wisdom and responsibility. Let it be your further confirmation that we offer TRUTH no matter how badly accepted or the threats against us for so-doing.]**

Most Americans are unaware of the constant propaganda with which they ARE bombarded, and are influenced unperturbed from sources which they believe are reliable.

The main thing which the Communists fear today is that the American people will wake up, before it's too late, to the truth about their conspiracy. The only chance Americans have of saving their country and civilization is to get across enough of the facts to enough fellow Americans in time.

This can be accomplished only by enlisting support from conscientious individuals and groups in circumventing the barriers of suppression and controlled distribution.

END QUOTING

Why have I chosen to center attention onto this book today? Because it is over **38-YEARS-OLD!!!** The letters I will share here are from 1955. If you think a little old cold war changing names means security and safety—forget it, it just means you are into another phase and that THEY have WON!

ABOUT THIS BOOK from the ADL:

QUOTE:

ANTI-DEFAMATION LEAGUE
OF B'NAI B'RITH

Henry Edward Schultz
205 E. 42nd St.
New York 17, N.Y.

October 4, 1955
Lieutenant-General George E. Stratemeyer
P.O. Box 424
Winter Park, Florida
Dear General Stratemeyer:

It is never a pleasant duty to impose distressing problems upon public personalities such as yourself, and for some time it had been our hope that this letter to you

might become unnecessary.

Just a year ago, the publishers of *Iron Curtain Over America* began distributing; as part of a sales campaign, copies of what purported to be a letter from you to John O. Beaty, the author, endorsing this volume and recommending it to Americans in general.

At that time we withheld writing you because we felt that inevitably the facts about Mr. Beaty and his book would be brought to your attention and that you would then take appropriate action. A year has gone by and we now find that "the General Stratemeyer Letter Written to Col. Beaty" is the subject of a flyer being distributed by Gerald L.K. Smith's Christian Nationalist Crusade. Enclosed is a photostatic copy of that leaflet, which you will note acknowledges unashamedly that *Iron Curtain Over America* is anti-Jewish.

This leaflet is being distributed in large quantities and thus links your name widely and publicly with the anti-Semitism of Gerald Smith and John Beaty. We take it for granted that you are familiar with Smith's long and notorious record as an anti-Jewish hater. Perhaps you are not as aware of Mr. Beaty's record.

Professor Beaty is no newcomer to the field of anti-Jewish propaganda. As long ago as 1948 he was delivering anti-Semitic lectures in the Southwest. Until December 1951 his activities were confined to desultory speaking engagements whose effects appear to be irritating only in a local sense. Then he made his debut as a national anti-Semitic propagandist with the publication of *Iron Curtain Over America*.

We do not propose to burden you at this point with our detailed analysis of the book; **[H: They rarely do!]** suffice it to say that it is a compilation of anti-Jewish lies and distortions which have caused it to become a kind of primer for lunatic fringe groups throughout the nation.

Lest you feel that ours is a partisan Jewish view of this book, we would point out that *Iron Curtain Over America* has been denounced by the Methodist publication *ZIONS Herald*. Others who have condemned it are Father J.J. Mulloy of the Jesuit High School of Dallas; Dr. Orval Watts in the publication *Faith and Freedom*; and William Henry Chamberlain in the *Chicago Tribune*. (Photostatic copies of these condemnations are enclosed.)

Finally, you should know that, as a result of his activities, Professor Beaty was censured in May, 1954 by the Board of Trustees of Southern Methodist University. **[H: Now we are getting there! Do you see how much POWER these bastards of truth, have?]**

In view of the foregoing, it is our feeling that you may want to consider the advisability of some public action which can assure the American people, who hold you in such high regard, that you repudiate religious hatred, as we know you do, and the use of your name by Professor Beaty and Gerald L.K. Smith.

We would appreciate your response which we hope will relieve the concern that has been expressed to us by the many people who have seen General Smith's newest leaflet.

Sincerely yours,
Henry Edward Schultz

END QUOTING

I don't know about you readers, but Dharma is not going to rest until somebody gets that book to her. ANYBODY HATED BY THE ADL AND UNDER ATTACK IS HER FRIEND!

Perhaps a few more readings from the PROTOCOLS might fit here:

QUOTE:

16. The monarches of the Christian world, swollen with ambition and vanity, surround themselves with luxury and with numerous armics. *We shall furnish them with all the money their folly demands*, and so shall keep them in leash.

18. For ages past the sons of Israel, despised and persecuted, have been working to open up a path to power. They are hitting the mark. *They control the economic life of the accursed Christians*; their influence preponderates over politics and over manners.

19. At the wished for hour, fixed in advance, *we shall let loose the Revolution*, which by ruining all classes of Christianity will *definitely enslave the Christian to US*. Thus will be accomplished the promise of God made to his people.

END QUOTING

What is hard to remember here is the connection to the subject of Communism. **You must hold uppermost in mind: Lenin was a Jew and so was every other member of the council in the structuring hierarchy of the Communist takeover of Russia!**

QUOTE:

George E. Stratemeyer
Lt. Gen. USAF (Ret.)
P.O. Box 424
Winter Park, Florida

12 October, 1955

Mr. Henry E. Schultz
National Chairman
Anti-Defamation League
of B'nai B'rith
205 East 42nd Street
New York 17, N.Y.

Dear Mr. Schultz:

Your letter of 4 October, 1955 with enclosures received and I want you and your organization to know that I forcefully resent what you have said or implied.

First, I want to make it clear that I am not, nor have I ever been, anti-Jewish. I have many Jewish friends throughout this country, who are loyal honest Americans.

As for your use of the meaningless expression "anti-Semitic" it makes no sense. According to the dictionary, the word Semitic pertains to the decendants of Shem which includes Assyrians, Hebrews, Phoenicians, Arabs, Abyssinians, etc. It also pertains to the Semitic languages collectively. Therefore, how any one person or group of persons could be anti-Semitic is beyond my understanding.

Who are you and your organization to tell me what I should read and what I should recommend other loyal American citizens to read? And, by the way, just what is the purpose of your organization?

Not until I read John Beaty's book *The Iron Curtain Over America* did I learn what was going on back in the United States of America while I was overseas fighting for my country.

I think every loyal citizen of our country whether he be Protestant, Jew, Catholic or Mohammedan should read *The Iron Curtain Over America*. I do not consider that book anti-Jewish in any sense of the word. In fact, I consider it a defense of all loyal American Jews and every Jew that loves these United States of ours should read it.

What connection exists between Mr. John Beaty and Mr. Gerald K. Smith I have no knowledge as I do not know either gentlemen. I did authorize Mr. Beaty to use my letter to him and that is no one's business but my own.

Then the United States of America reaches the point where a citizen cannot read what he desires to read and to recommend such reading to others then we will have reached the status that exists in Soviet Russia. But, THANK GOD, we are still free men in America. As I interpret your letter your organization would have the people read only what you think should be read and recommended to others. This I resent as a free American citizen.

I do not understand what you mean by your statement, "We do not propose to burden you at this point, etc." Is this a veiled threat to my free expression and thoughts? If so, this I also resent.

Your letter is the most outrageous communication I have ever received in my life and I intend to give it the widest possible publicity, including my many Jewish friends.

Sincerely,
George E. Stratemeyer

END QUOTING

May the "Force" be with you! Salu

Ray Renick Telephone Call July 27, 1993

I've got a couple of pieces of information for you. There's a friend of mine, her name is Susie. She is very astute. She's been researching stuff like I have for twenty years or so and she's got a fantastic library and you really should interview her especially about me. She knows a whole lot of stuff.

Now, she has a friend that told her that I was being railroaded and everybody knew it and they told these friends of mine who are political activist too, they said, "Anyone who tries to help Ray Renick will get the same treatment."

Now David Pomeroy is prosecuting the case and he is part owner of where that drug lab was on that map that I gave the Contact office. He is one of the "gang". He has his name next to Baggett and Wolpert and all those guys. Actually, the Pomeroy's own all that land around there, where the drug labs are and it's not too hard to find this out because everybody knows it. There's a road that runs right through that property or somewhere around there called Pomeroy Road. Now, it's not named for John Smith! Everybody knows who owns that, of course, his name wasn't on the deed at the time of the drug bust and the murders. Do you know what I mean?

I spoke with Jim V. and he told me yesterday that there is a trucking company out of Kentucky or Tennessee. It comes up from Mexico. They are specially built trucks and they bring babies up and they have these babies in satanic rituals. The name of the trucking company is PTL, Pascal Truck Lines. You know, Pascal lamb as in the Bible, the sacrificial lamb? They bring these babies up by the hundreds. They buy them or kidnap them or something. I don't know for certain. I guess babies are cheap down in Mexico.

He also was telling me that in England and in Holland they are building huge dykes out into the ocean. They are doing it to resist seismic waves from earthquakes and stuff like that.

Since I've been in here I've only had one or two visitors and I think they are scaring people off on that too. I've told them to tell the people in the press that if they want a press conference that they can come during visiting hours and visit me here like a regular visitor. They're probably trying to discourage that type of thing.

Well, I'd better get off the line now. Bye.

Help Demjanjuk NOW Or Seal Your Own Fate

8/1/93 #1 HATONN

**SEEING IT IN ACTION BEFORE
YOUR EYES**

What do you THINK is happening with John Demjanjuk in Israel? Now, the Israelis will not allow him to be deported—even to the Ukraine. Why do you suppose that is? How can you now say that you are "going to dig up new evidence that Demjanjuk served the Nazis"? Since the Protocols say to create evidence and have as many witnesses as you need to crucify—then it would seem that something is afoot—BEYOND A "SIMPLE" TRIAL—WHAT MIGHT IT BE?

What it is is that it is now KNOWN that you-the-people of the United States are demanding restitution to this man of his rights under the U.S. Constitution! The Israelis CANNOT ALLOW FREEDOM OF DEMJANJUK IN AMERICA AND, NOW, ANYWHERE ELSE FOR THE WORLD'S ATTENTION IS FOCUSED. THEY CAN'T EVEN KILL HIM AND SHUT HIM UP OR THE PEOPLE OF AT LEAST THE U.S.A. WILL CRY FOUL!

The Israelis who have orchestrated this gross miscarriage of justice upon an innocent man and "you-the-people" were

FIRST in the United States. It was demanded by the "Lobby" of Israel that the man be picked up, stripped of his citizenship of decades and shipped illegally AND unlawfully, out of the Americas. Do you think the Administration and the guilty parties of very, very high rank in your government WILL ALLOW THE UNCOVERING OF SUCH CONSPIRACY? Oh citizens, watch CLOSELY—for there, in a very short while, GO YE! You already have hundreds and hundreds of political prisoners which are just now coming into a wee-tad of your attention! Is there difference in this MAN and the Christed Man 2000 years ago? NO! Only the manner of DEATH OF THE BODY! Will YOU go to your own grave with THIS on YOUR soul? We shall see. Why does not God snatch Demjanjuk out of his plight? BECAUSE YOU ALLOWED THIS AND DID THIS AND YOU WILL GIVE HIM FREEDOM AND JUSTICE OR IT WILL NOT BE. HE HAS TO CONTINUE TO LIVE IN YOUR WORLD OF SLAVERY AND INJUSTICE OR PERISH, AT YOUR DEMAND FOR IF YOU DO NOT STOP THIS MURDER PLANNED—THEN IT IS ON YOUR HANDS AND NO AMOUNT OF "WASHING" WILL CLEANSE IT FROM YOUR SOUL!

Patriots: It's Time To THINK!

8/1/93 #1 HATONN

RAY RENICK/JIM VASSILOS

I would like to speak here a moment in regards to an open letter (of sorts) from DORIS EKKER regarding HER frustration and pain dealt forth by this one, Jim.

In response to that writing, Ray Renick called the CONTACT office in a fit of tantrum and said that "Hatonn" was this and that and was all but out of control. If ones cannot read better than that and perceive better than that—then why do you EX-

PECT anything from these people OR FROM ME?

The Ekkers HAVE HAD ENOUGH. They have personally gone out to the tips of the limbs to help ones such as Renick AND Jim Vassilos—at the risk of exactly what has happened. Nationwide attack for misuse of funds from Green and other places which threaten their very own freedom. To then have the very one helped at this risk, call in the middle of a "meeting" with a guest speaker and blast our people is unacceptable. Whatever may be the feelings about Ray's incarceration—HE DID IT HIMSELF!

I personally asked him NOT TO REACT in the manner in which he did and he chose to do so anyway. The only path NOW is to effort to find cause to get him out on the basis of unlawful "other" causes than his arrest. If this is not suitable to Ray then we have no recourse and will certainly bow out as gracefully as can be arranged, from his affairs—BUT HE ASKED OUR HELP WHICH HE NOW SPITS UPON. Does he do it intentionally? Well, if it is not intentional—it is certainly "uninformed".

As to the cause of Dharma's speech—my goodness, people, what do you want of these two persons? A phone call came threatening mass damage to the Ekkers, suits to the paper, the JOURNALS AND PERSONAL SUIT against the Ekkers. The assault was caused in full precipitation by Jim Vassilos and his "help" as he saw fit to offer it—but at the expense of others.

Jim has been personally helped financially as he presented needs to E.J.—none of which has gained one iota of help for anyone, possibly not even himself. He has brought forth attorneys who will help, he says—only to find "they" don't know a damned thing about anything—especially their "helping".

Jim is personally responsible for "helping" Gunther R. to the extent of getting the most important documents Russbachers shall ever have in the world of business survival—confiscated, through "carelessness", by the prison system—and GONE—POOF!

A car was rented FOR the convenience of Jim—which was wrecked! Rayelan and E.J. paid for it. "Doris" hardly knows Ray Renick—AND DOES NOT KNOW JIM VASSILOS AT ALL! She does the central work which makes everything in the worldly format—possible and physical in use and acquisitions. There would be no Institute to quarrel over, no paper to sue, no JOURNALS to fight over and certainly NO GOLD IN GEORGE GREENS POSSESSION—WERE IT NOT FOR DORIS EKKER. She is the one who must stand in Federal Court and take FULL RESPONSIBILITY FOR EVERYTHING I HAVE DONE—RIGHT TO FULL CONTEMPT CHARGES AND SANCTIONS WITH "PROMISE" OF IMPRISONMENT IF ONE MORE THING IS BROUGHT TO THIS JUDGE'S ATTENTION AND CAN BE PROVEN. (DEMJANJUK???) For ones to come to her, threaten, blast and insult. ("Oh, are you that UFO lady....." etc., etc.?) and then guarantee a lawsuit—is, yes, unacceptable to ME.

If Ray cannot read better than this—then how can we trust HIS WORK to pass on to you readers? If Jim doesn't KNOW THE DIFFERENCE IN DORIS AND HATONN—THEN WHAT ARE WE DOING ANYWAY? WHILE HE MAKES TROUBLE IN HIS GOOD INTENTIONS—HE COULD

BE FINDING OUT WHAT WE ARE "ABOUT". THE ROAD TO HELL AND PRISON ARE PAVED WITH **GOOD INTENTIONS!**

What is Jim's purpose and involvement? Who knows? The point is that in his exuberance or intentionally—he does rash things, states undocumented evidence and spreads it around under the headline of someone ELSE! He uses phones and FAXes of others and generally stirs up great turbulence for others to quiet. With this kind of friendly help—WHO NEEDS FULL BLOWN ENEMIES? Dharma (Doris) has ONLY FELT THE SCORPION STING AND WATCHED THE OUTGO OF MONEY WHICH MIGHT JUST GET RAYELAN TO THE DOCTOR BEFORE SHE BLEEDS TO DEATH. INSTEAD THE FUNDS HAVE TO GO TO REPAIR A WRECKED RENTAL CAR.

I suggest that everyone THINK before "reacting" for in many instances, and this one is a biggie—the reaction is NOT a "response in thoughtful wisdom" and possibility of truth—but a foolish lashing out AT THE WRONG BEING. Moreover, this is the very type of activity that has gotten you loss of your *Constitutional* rights—doing and not having any idea WHAT you are doing! "But I thought...." doesn't cut it after the head is severed from the body!

We find that MOST of the things Jim tells people, even our crew, is lacking in truth in full. Every story has some invalid information which is both embarrassing and damaging in follow-up. Is this simply a trait of "lawyers" no matter who they might be or wherein they might "serve"?

Now, I ask you readers, how can "I" ask Dharma to risk her life and freedom to continue her work—for one who has just blasted her incredibly for dealing with that which IS? Do "I" insist that she go on and do this work so that there is funding to help these men at the risk of being totally stopped and incarcerated? At that point there will be NO FUNDS TO CONCERN ABOUT AT ANY RATE! OR, IS THIS VERY THING—THE POINT AND INTENT?

Where does Jim think help from here comes from?

Where does Ray think help from here comes from?

Where does ANYONE think help from here comes from?

IT COMES FROM AND THROUGH THE HANDS OF ONE DORIS EKKER! IF SHE IS TOLD THAT ANOTHER SUIT **IS BEING BROUGHT AGAINST HER** BY ONE FULLY INTENT OF EXACTLY THAT—BECAUSE ANOTHER HAS SOMEHOW SCREWED UP—WHAT DO YOU EXPECT HER TO DO? I rather felt she had a right to express herself and perhaps put the "caller" in a position to understand "she" had nothing to do with anything and did not, nor does she now, know either the caller OR Jim Vassilos. She spoke to Jim ONE time on the phone when he called collect FROM

JAIL—requesting help to get him out. That was forthcoming even though it took several days just to get him covered and free. The THANKS? He was free and back wherever he came from and did not even notify these people until long after the fact when another "favor" was needed. Dharma, frankly, doesn't have many more teeth to kick out, "help seekers". We are NOT dealing with a "robot" here. There is a plaque on her door which the friends place there: **"NOTICE: DUE TO THE SHORT-AGE OF ROBOTS, SOME OF OUR WORKERS ARE HUMAN AND WILL REACT UNPREDICTABLY WHEN ABUSED!"**

This is exactly what happened for the "predictable" response from Doris is, "Oh, forget it, I can handle another lawsuit from a stranger!" However, **SHOULD SHE RESPOND IN SUCH A MANNER?—EVERY LAWSUIT DRAINS MORE FUNDS AND STAMINA!?** Does she have a right to allow this nonsense to be dumped on ones already so overburdened and undercompensated as to go without—to help these OTHERS who actually got themselves into their own "fix"?

I believe that apologies may well be in order! Especially if ones expect further assistance from this resource. You ones seem to "recognize" "Me" when it is convenient and "disbelieve" or "doubt" when it is more convenient. So be it—I suggest that this time you are dealing with an unpredictable human being who prefers not to further damage the working crew in this location—much less allow them to be insulted and chided about "my" misperceived (since I didn't write the message) statements. Many involved here have suggested a hearty "Up yours, Mssrs. Ray and Jim" from her and a final "thank you" but "no thank you".

Do any of you people caught up in your own projects and personal circumstance consider how YOU and YOUR personal agenda impacts others?

I note that Devvie Kidd has some fabulous ideas—impractical but fabulous. However, since we seem to be on her "S. List" (skip) we are not in point—but she has labelled a lot of patriot groups and leaders as "bad and unrighteous" because they do not agree with a "March on Washington". She perceives tens of thousands at the Capital while SHE deals with the Congress???? Come now—I don't know any REAL PATRIOTS WHO CAN ON THEIR OWN ACCOUNT—AFFORD A TRIP TO WASHINGTON D.C. UNLESS THEY LIVE THERE. Does this make you a poor patriot because you cannot attend or participate OR, choose not to do so—with her and her group? What are you doing, citizens? Divide and conquer in full swing! Hardly ANY "patriot group" wants to have another lady or group get all the glory—this is, again, PREDICTABLE human nature.

Besides, some of the groups on her list are fully aligned WITH YOUR ENEMY! IF SHE DOES NOT KNOW AS MUCH—THEN **SHOULD SHE HEAD SUCH A MASSIVE MARCH ON ANYTHING?** Can we not appreciate the approach of another, in grace and hopefully, understanding? We got on Devvie's "list" when we defended Bo Gritz from the attack that he had made "boodles and bookoo" dollars on his campaign trail, a new plane and generally "had" the constituents. NO, he didn't—he about had a breakdown, physically, from that campaign. What happened was that he failed to properly THANK the workers and give full recognition to participation. He SHOULD HAVE, but this DOES NOT MAKE HIM EVIL OR A THIEF.

I feel she did what she could and herself became sick and debilitated. She did not, however, stop pushing for that which she perceives as possible recovery of that which is YOURS. She spoke of "Cosmos" and contacted the REAL Cosmos people to effort to sort out the dregs from the truth. She has acted responsibly—that does not mean that ALL her actions are either RESPONSIBLE or the MOST worthy attempt at gain.

WASHINGTON D.C. **IS THE SEAT OF THE BEAST** in your nation. Why march on THEM?? There?? This RECOGNIZES their power and control over you and the bastards who are the buzzards in power WILL NOT DO MORE THAN POLITICIANS ALWAYS DO—AVOID, DECEIVE, PROMISE THAT WHICH IS NO-WAY TO BE DONE—AND WASTE YOUR TIME AND ASSETS AS DOES ANY OTHER SUCH DEMONSTRATION! The same number of citizens marching "with the pen" and investing the SAME OR LESS amount of money—can sweep the nation! This is not the point. To say that it is now the "fault" of ones who choose not to participate are "COSTING" THE RECLAMATION OF THE CONSTITUTION AND THE NATION'S FREEDOM—IS HARDLY "FAIR"—FOR "THAT" IS A PART OF THE CONSTITUTION—TO ACT AND SPEAK AS YOU CHOOSE!—OR NOT.

I speak of this simply because I have been asked for comments. I would have run more information about the "march" and plans—had I had responsible literature prior to last evening—but what you do is your responsibility to discern and judge. WE have a mission and it is OUR responsibility to see to IT. We cannot even afford to financially send a journalist to the encounter—we depend on others, whom we will assist to get there, to share a report with us for you readers. Beyond that, I have no comment for it is not my "right" to do other than present the information to you. For it to be inferred that certain ones are NOT good patriots because they either didn't respond or responded negatively is, I believe, without merit. She has named

some who actually serve in the "Committee of 300's Cartel or, at the least, use the movement and actions for financial gain. (She had that one right!) Nobody here Knows this person—so why would we have an opinion? If you can, and wish to join in a march on Washington in behalf of the POWs—please—do so. However, marching OVER the bodies of the ill-perpetrators would seem more suitable—to get to the ballot boxes at first chance—to pull them down from their seats of power.

A lot will say: "Well, it's better to do something, even if it's wrong, than to do nothing." **Who said such a thing? IT IS NOT! IT IS BETTER TO JOINTLY PLAN AND THINK THROUGH ACTIONS AND THEN ACT IN WISDOM (EVEN IF IT BE TO KEEP STILL IN PROPER SEQUENCE) THAN TO BLAST YOUR WAY IN WITH WRONG AND FOOLISH ACTION.** Surely your "enemy" wrote that old saying—**OR, THE CIRCUMSTANCES WERE DIFFERENT???**

Bo Gritz: Patriot Or?

8/1/93 #1 HATONN

BO GRITZ

Ah, now comes the next inquiry: "Is Bo Gritz still or back on your good list?" Bo Gritz was never OFF my "good list"! What is he doing? That is his business—not mine! He is a most beloved brother/son of myself and what he does is between himself and God—and "they" don't need me to stick my nose within. A lot of "errors" in judgment and action is lying there in the path—I suggest that "him who is without sin—cast the first stone!" Perhaps he has "given up"—but that really doesn't sound like a Marine Colonel to me, does it to you? He needs to gain insight into what IS and the unfolding of GOD'S plan before he can whip through his! He has been "used" by the system at a level that affects the SOUL and if you think YOU are brainwashed as to truth and lie—what about ones who have spent YEARS in enforced brainwashing PROGRAMS with deliberate attempt to bring them into robotic tools? ON the soul of a man WITH SOUL, lays heavily past actions which rips the "guts" right out and into shreds and tatters. You cannot perform that which many of these gifted men intended to serve GOD, were required participation—and sleep the rest of the innocent child. Oh, they can "forgive" self—but it does not suffice for the fullness of PEACE on conscience and it becomes easier to "survive" to put aside that which pains and reflect in respite with that which is recognized, if not approved.

Man looks and seeks endlessly for the "religion" which will bring peace—there is NONE. What one seeks is that which will give sanction to his own actions—and if the actions be in any way at all adverse to those laws of God—HE WILL NOT FIND! He may well find "some" but not ALL. In the end he will know that "I" AM the way and the WORD! I have all the time in the UNIVERSE—you have little.

Why does Dharma and E.J. and the

others here—continue beyond all endurance and responsibility? BECAUSE THEY KNOW! At that point the WORK becomes the JOY and the other things of physical experience become the WORKLOAD FROM WHICH THEY SHRINK AND DREAD. The WORK work, is the vacation!! Ones can go off into the mountains or valleys seeking communion and the "diamond" of priceless—only to find that it is in their own backyard—waiting until you take time to see it sparkling there. Go, if you wish, but do not lie to self. Go because you WANT TO GO. God will not SEND you anywhere ELSE than where you are for HIS needs.

CHANGING BELIEFS

You cannot change "beliefs" like a pair of socks. I am asked why would I allow someone with divergent teachings and "beliefs" to spend time with us? What mean you? If a man has beliefs—allow him to share. Are your beliefs such that they can be swerved away from your path? If yours be truth you CANNOT be moved away! If his be TRUTH—then YOU SHOULD BE MOVED! THE POINT IS TO KNOW WHICH IS TRUTH! Remember, that to each man his own truth—IS TRUTH. This does not mean that all save one point may well be absolute Truth in God. The one tiny point deviation may well be in great error? This does not make the Truth less the Truth. If you study your WORDS sent forth by ANYONE, ANYTIME the deviations will be recognized and then, ONLY THEN, can proper judgment be made upon that given subject in point of discrepancy.

This does not mean that we "insult" or pick against that "other". We welcome and share that which we can, allow him that which is concluded "incorrect" (possibly) and then offer him another view that he may have, not offense, but desire to hear your own truth.

Most often MAN will find words in a portion of the Holy Books which support

his VIEWS! And, will overlook the opposition view found elsewhere in the very same BOOK! Watch this contradiction and if this action has been TRULY offered and ordered by ones in other realms of expression—take very, very careful heed. Just because those energy forms are dead and in spirit form—does not make them your friend. But, if they be your friend, YOU WILL BE TESTED AS TO THAT WHICH IS TRUTH IN GOD AND THAT WHICH IS PERCEIVED BY MAN PHYSICAL. IF IT BE PHYSICAL—IT IS OF MAN!

If, as with the most current question, a man proclaims polygamy as his right and duty, carefully look at this. What is actually being said? Marriage by contract and sexual consummation ARE BOTH nothing but expressions of physical body. The "marriage contract" of the soul is made with God and requires NO PHYSICAL CONTACT OF ANY SORT! P.S.: GOD DOESN'T NEED TO SCREW AROUND TO HAVE OFFSPRING! THAT IS SOLELY AN ACT OF MAN PHYSICAL. So, what happens? A man experiences that which he cannot fully understand. Then he goes forth to find reason and meaning. Perhaps he has been touched by God himself and honestly "seeks". Therefore he will then seek out that which applies to his circumstance and bases his actions upon POSSIBLY the incorrect assumption. It is EASY to tell whether a thing be "right" or "wrong", physical or spiritual. If a thing require physical ACTION it is predominantly physical even if it be thought to be spiritual in intent. If it be spiritual—with insight and communion—the direction will be made clear IN A SPIRITUAL RIGHTNESS SURPASSING THE PHYSICAL EXPRESSION.

THE POINT OF ACTION

The point of action is in such a manner as to give no man opportunity or reason to act or speak against you under the law of the land or the Laws of God. I use my own self as example—we ACT ONLY within the laws of both Land AND GOD! No enemy can FIND VALID REASON to bring any action against us. THEY DO SO—BUT THEY DO SO WITHOUT MERIT AND CAUSE OTHERS TO ACT AGAINST US UNLAWFULLY AND IMMORALLY. In other words, our actions must always be such that to bring fault or action against us it must be done in dishonesty. Remember that if a human person acts against another in gross and intentional illegal and unlawful means—he must live with self as well as society—in other words, his action is now before GOD IN LIGHT and he can be stricken in many ways—even by his own fellow traitor.

The "goodly" cannot always control the system—in fact, can rarely control the system. BUT THE SYSTEM KNOWS THAT

THE GOODLY AND GODLY MAN HAS GOD ON HIS SIDE AND—IN THE ENDING—WILL PREVAIL. IT REQUIRES DIRECT AND INTENTIONAL ACTION AGAINST GOD HIMSELF TO STRIKE DOWN ONE OF GOD'S SERVANTS. MOST "REASONING" MAN BEINGS WILL CAREFULLY CONSIDER THE CONSEQUENCES OF SUCH BLATANT ACTION.

Lessons In Discernment

8/1/93 #1 HATONN

GREEN GOLD

I have a bit of an example here, again, with "Green" and the "gold". He is making calls again—all over. One call was made to America East in which George said very sarcastically: "Blank, I saw him (E.J.) with my own eyes counting the loot." Does this lie HELP George? No. So, why can't he see? Because he refuses to look! He is so busy protecting his own ego that he cannot resist any lie which may discredit another—or clear himself. The fact that there is NO TRUTH AT ALL is far more "sick" in realization but it shows desperation in any event. Will that lie hurt E.J.? Of course not—it can only assist in "making a better case if there ever gets to be an honest hearing." There is already enough evidence of George LYING in the courtroom under oath, to the Judge—to cause him to be disallowed from representing self in trial. This is a pretty bad mark on a man's record, readers. Will it come to this? Eventually—or it will be ended in some manner. George has run away from his jurisdiction to "escape" as he did prior to this at the time of the insult. He has been paid by the adversarial forces to keep the WORD buried and that will be stopped (I hear from pretty good inside sources) and so, what will the deserted man do? I warned him that when the adversary gets through with you—you are dropped and cast aside as garbage. If you are too much of an embarrassment—they "take you out". Will George then come to God and ask protection? Wouldn't that be grand? Well, I think the petition would probably be more selfish asset-saving intent—but until the 12th hour striking—God is available!

I marvel that one such as Ray Renick would be so thoughtless (unless he has not read all our work and basically disbelieves) as to bring one iota of pain more to my scribe—KNOWING the hard reality of that which has come against these two people from the adversarial forces. Does it not imply that Ray and Jim and others—are

simply more of the adversarial troops efforting to destroy her? How would YOU think about it were it you? Ray, himself, thought the push and attack and game, up to arrest, was one way—only to turn frantically for HELP to us when the actuality of experience STRUCK. Walk first in the shoes of the other person before judging those shoes. At this point in time—Ray is being treated quite well in prison and with your emotional support and love he will be fine and stable when his time of hearing arrives. If he continues with outbursts, he will lose credibility and that is WHAT THE ENEMY WANTS—NOW! They can't get him on lawbreaking because more laws were broken against him than him against "them". So, make him act out in non-socially approved behavior and he will be socked away in a prison-mental institution for the rest of his days. Proving a man to be "SANE" if the system says he is insane is all but impossible—for in 24 hours a liquid-lobotomy can be done and the man is insane! To push is the game of martyrs and GOD NEEDS NO MARTYRS IN THIS FINAL PUSH—HE NEEDS LIVING, REASONING PERSONS! WHICH ARE YOU?

Dharma, forgive me for bringing these sore points to public. I see the hurt that I would ask you to look squarely at facts for you tend to hide beneath my wing and ALLOW without recourse—even when it is unwise. I cherish you, and all of my friends, beyond myself most surely, but, chela, silence is not always the best ap-

proach—lest the festering boil increase and rupture—or poison and KILL. You have accepted, first of all, duty to service unto GOD—not a space cadet who speaks a lot of words—in wisdom or not. To allow smoldering pain corrupts the heart in self-defense and the way becomes "duty" and not joyous love of giving. I do not relinquish your commitment to service nor do I relinquish my Command or my own service—SO, what have we? Choices. Always choices! If you ones wish to be members of my team—you will THINK MOST CAREFULLY AND GET FACTS before erupting in any manner at all. Is this a fit of some kind from Doris? No, the call came in a meeting and she knew nothing of it as ones efforted to keep it from her. The facts "slipped" out in a phone conference with ones totally detached. So be it—THAT WHICH YOU DONT KNOW—CAN HURT YOU! BUT IN KNOWING—YOU CAN CHOOSE AS TO WHETHER OR NOT YOU ALLOW IT TO HURT YOU. Is this not the material upon which ALL wars are "pretended" to be based? And is it not actually ALWAYS orchestrated into pushing ones into the fray? Ponder it. You will not win this war with God by blundering profoundly stupidly through the hours until you take-off or evaporate or whatever! The sooner this lesson is learned—the faster we can get on with this "rapture" business in God presence.

Thank you for your attention.
Salu



This editorial cartoon is by Ben Dib of The Sun. Letters to him may be sent to The Sun, 399 N. D St., San Bernardino, Calif. 92401.

THE BANKS AND THE C.I.A. CASH & CARRY

BY PAUL MUOLO AND
STEPHEN PIZZO

How Agency rogues fleeced financial institutions to help create one of the greatest scandals in U.S. history.

When a sheriff asked legendary bank robber Willie Sutton why he kept robbing banks, his answer was to the point: "Because that's where the money is," he snapped.

For the Central Intelligence Agency, "where the money is" had always meant a sometimes stingy and timid Congress. But some of that changed in 1982, when federally insured banks and savings and loans were deregulated and the C.I.A. learned that Willie Sutton had been right

all along.

This exclusive investigation, by the coauthors of the New York Times best-seller *Inside Job: The Looting of America's Savings and Loans* (McGraw-Hill), reveals how freelance C.I.A. operatives—in the course of carrying out covert operations—fleeced America's financial institutions.

* The owner of a freight airline that shipped guns to the Middle East and Central America kept the operation afloat with loans from a bank at which he was a director. The loans were never repaid and the bank has since failed.

* A Baltimore banker finds himself serving a C.I.A. front company and arranging over \$20 million in arms deals

before being hung out to dry by the agency.

* Acting as a middleman for arms shipments to Afghanistan, Iran and Iraq, and Central America, a C.I.A. contract pilot helped bilk a Denver bank out of more than \$2 million.

To understand why the C.I.A.'s rogue operatives preyed on financial institutions, it's necessary to go back to the days before deregulation, back to Jimmy Carter's insistence that the C.I.A. sweep the "cowboys" — the trouble-some covert-operation officer — from its ranks. The C.I.A.'s job, Carter believed, was to collect intelligence, not assassinate people and orchestrate coups. Finding themselves on the outside, the cowboys

WHO'S SPOOKIN' WHO? A Cast of Characters

Farhad Azima: Iranian-American; ran Global International Airways Corporation; involved in arms shipments with C.I.A. rogue Edwin Wilson; borrowed nearly \$1 million from failed Indian Springs State Bank in Kansas City, Kansas, to fund Global's operations, later showed up in the Iran-contra affair.

Richard Brenneke: Says he was approached nearly 20 years ago by the C.I.A. while he was teaching philosophy at Saint John's University in New York; left and started his own investment firm specializing in offshore investments; claims to have participated in an October 1980 meeting between Reagan-Bush campaign officials and Iranian officials at which the Iranians were offered a \$40 million bribe to hold the American hostages until after the election.

Everett Lemaster: President of Indian Springs State Bank, killed in a car crash after he tried to comply with regulators instructions to rid the bank's books of loans to both Global and organized-crime figures.

Robert Maxwell: Former executive of First National Bank of Maryland who was asked by his employer to arrange the financing for arms shipments

through a C.I.A. front company called Associated Treaders Corporation. A soft-spoken family man, Maxwell agreed to take the account for the bank but soon discovered that the arms deals were probably illegal. When Maxwell demanded that the bank take his name off the account, he charged in a lawsuit, he was threatened by bank officers.

Lloyd Monroe: Former assistant U.S. attorney in Kansas City, Kansas, who complains he was told by the C.I.A. to drop his investigation of Farhad Azima's Indian Springs State Bank loans.

John Napoli, Jr.: East Coast mob associate of the New York Genovese family; worked with Heinrich Rupp in a scheme to relieve Aurora Bank of some \$2 million. (Napoli was never charged in the caper.)

Marlo Renda: East Coast money broker who placed large sums of teamsters pension-fund money into Indian Springs State Bank as brokered deposits; an associate of Saudi arms dealer Adnan Khashoggi. Renda is currently serving a five-year prison term for three convictions, two involving the fleecing of Indian Springs State Bank and Florida Center bank in Orlando (which Renda looted with Mike Rapp). The third charge involves the bribing of pension-fund officials.

Heinrich Rupp: Resident of Aurora,

Colorado; ran a precious-metals business and flew for a number of charter and freight airlines; has bragged that he was one of Hitler's youngest fighter pilots at the age of 14, claims that after the war he was asked to work for U.S. intelligence. (Since then, he says, he has flown for the C.I.A. in most of the world's hot spots, including Laos, Vietnam, Beirut, and Central America. The agency admits he was trained in 1966 at a C.I.A. proprietary airline, but denies that he ever worked for the agency.) Rupp was convicted in 1988 of defrauding Aurora Bank of \$2 million.

Anthony Russo: Kansas City attorney who represented Civella-family members until he himself was convicted in the early 1970s; became an officer at Indian Springs State Bank and a consultant for Global Airways.

Edwin Wilson: Former C.I.A. agent turned arms dealer, his company contracted with Azima's Indian Springs-supported Global International Airways to fly military equipment to Egypt. Wilson is now serving a 57-year sentence for selling arms and explosives to Libya and for attempting to hire assassins to murder witnesses and prosecutors involved in the cases.

kept in touch with the handful of covert officers left at the C.I.A. Together they quietly kept the agency's covert operations alive. "The covert people at the agency simply cut the President, C.I.A. Director [Stansfield] Turner, and the N.S.C. [National Security Council] out of the loop," said Gary Sick, Carter's national security adviser for Iranian affairs.

When Ronald Reagan was inaugurated in 1981, his C.I.A. director, William Casey, wanted to reinvigorate covert operations. But rather than bring back the cowboys, he left the underground network in place — in order to save himself a lot of headaches with Congress. After all, he needed to get guns to the Afghan rebels, he needed to contain Communism in Central America, and the Iran-Iraq war — which suited the U.S. and Israel just fine — deserved plenty of discreet support and encouragement. The independent covert network could be very useful, but it had one big problem: money. Casey could not fund their activities out of the C.I.A. budget without going to Congress, so the cowboys had to cover their own operating expenses. The funding challenge resolved itself in 1982 when the sluice gates opened on the banking industry.

Ronald Reagan had promised to get government regulators off the back of American business, and that October he made good on his promise by signing the Garn - St. Germain Act into law, which deregulated the nation's savings and loans. Deregulation meant fewer regulators to patrol these institutions. In addition, a clear message went out to banking regulators that this administration wanted financial institutions cut loose from their old stodgy, traditional, government-imposed ways. Instead, financial institutions should be allowed more room to wheel, with less interference from federal examiners.

Deregulation gutted the ranks of both federal and state bank and thrift regulators, and those who were left found it increasingly difficult to report irregularities without becoming the target of pressure and ridicule from superiors who didn't want to get out of step with the party line.

The result of deregulation was predictable: billions of federally insured dollars vanished from banks and thrifts. Mobsters, con men, and sleazy businessmen hauled it off day and night. They weren't the only ones, however, to see the potential in this regulatory laxity. Even more ominous, it now appears that the C.I.A.'s stable of freelance operatives also took full advantage of the situation, using federally insured bank and thrift money to fund politically un-

popular covert activities.

THE LITTLE BANK THAT COULD

On September 23, 1988, self-described former Nazi Heinrich (Harry to his friends) Rupp, 58, faced sentencing before Denver federal Judge Jim R. Carrigan. Rupp could have received a 42-year sentence for a stolen-currency scam that cost the Aurora Bank of Denver over \$3 million. The judge had heard testimony detailing Rupp's involvement with a cast of seedy characters, including East Coast mobster John Napoli, Jr., in a scheme to buy \$9 million in stolen currency with \$2 million in loans from Aurora. Needless to say, the \$2 million disappeared and Rupp's several Swiss bank accounts were empty when investigators got to them.

Just as Judge Carrigan was about to pass sentence, defense attorney Michael Scott stepped forward. "Your Honor, I have a special witness I'd like the court to hear in chambers." A few minutes later, special witness Richard Brenneke, a businessman from Lake Oswego, Oregon, was telling Judge Carrigan a story only a nut, a spy novelist, or a spy could conjure up. Brenneke told the judge that he was with the C.I.A. and that Rupp was, too.

Brenneke said that he and Rupp had conducted covert operations and flown planes for the C.I.A. for the previous 18 years. What's more, Rupp's involvement with Aurora wasn't what it appeared: Rupp was the victim of a C.I.A. plot to discredit him because he knew too much, particularly about the C.I.A.'s contra and Iranian arms deals and how they were financed. The C.I.A., he claimed, had sanctioned a widespread program whereby its operatives pulled money out of federally insured financial institutions to fund covert activities, particularly arms deals.

Then Brenneke explained to Judge Carrigan that certain people in Washington were nervous about Rupp's case because Rupp supposedly had flown future C.I.A. director William Casey to a series of secret meetings in Paris in October 1980 — one month before the presidential election. Attending the meetings, Brenneke claimed, were vice-presidential candidate George Bush, Bush aide Donald Gregg, and the campaign's senior foreign policy adviser Richard Allen. Brenneke, who said that he had attended one of the meetings, told the court that Casey, Gregg, and three other Americans met with Iranian officials and offered them \$40 million if they agreed not to release the 52 American hostages being held in the American embassy in Tehran until after the election. The money

was to be used by Iran to purchase arms.

Rupp set tight-lipped throughout Brenneke's testimony. He would confirm only that he "was in the process of departing from the agency as a contractor" when he became involved in the bank deal. After a psychiatric evaluation that showed Rupp to be a sane and "truthful person," Judge Carrigan sentenced Rupp to 18 months in prison and six months at a halfway house. Attorney Mike Scott says that he's seen enough to convince him. "The C.I.A. was obviously raiding banks because they couldn't get the money from Congress," he explained.

Scott also confirmed that Rupp was a loyal C.I.A. contractor who flew scores of secret missions: "Hell, he even flew mules to Afghanistan." Rupp was, in fact, at the very center of America's covert-arms agenda. Telexes addressed to Rupp's now defunct Colorado company, Avconsult International, Inc., read like multimillion-dollar shopping lists of death and destruction:

*Attn. H. Von Rupp
Re: Your offer via **FUAD***

Inform you that we have already fixed the appointment with Irakies [sic] at Wednesday this week....Pls carry all avail docs with you to convince buyers abt yr merchandise. You will deal with direct govt people here in Geneva.

*On the other customer, pls send yr offer immed to buying authorities, since they are anxious...Offer addressed by tlx to: **TROFLOC** Tehran/Iran*

Another dated 1982 reads:

- 1. Have order from Iraq for 300,000 rounds and from Iran for 100,000 rounds. Is end user of this countries [sic] accepted?*
- 2. Can goods be marked with an Eastern Bloc manufacturer's mark?*

Months after the Rupp trial, the C.I.A. admitted that Rupp had received pilot training in 1966 at a C.I.A. proprietary airline, Intermountain Aviation, Inc., in Arizona. But did the agency know what Rupp was up to at the Aurora Bank? Former C.I.A. agent David MacMichael believes that agency officials might have been aware that their contractors were bilking financial institutions. The agency would not have acted, he said, because it would have wanted "to continue to use these people and didn't want to draw attention to them." Another retired C.I.A. agent, a former cowboy who spoke on the condition that his name not be used, told *Penthouse* it was entirely possible that the agency knew how its contractors were funding their missions: "I will not dismiss the charge that operations could

have been funded by looting S & Ls if it paid for contra operations." Peter Earnest, a C.I.A. spokesman, will only say that the agency "does not break the law" and dismisses all allegations that it was involved in bank or S & L scams.

But *Penthouse* unearthed a number of bank and S & L failures that involved individuals who claimed C.I.A. affiliation, and several who denied it, even in the face of convincing evidence to the contrary.

When Oliver North's personal desk diaries were declassified and released earlier this year, we discovered a familiar name: Joe Kelso, whom *Penthouse* had met in the course of researching Heinrich Rupp. Kelso told us that he was in lots of trouble with the feds in Denver for violating parole. In 1983 Kelso had gotten caught in a Customs sting operation trying to sell ground-to-air missiles. He says that he was simply doing his job: keeping an eye on Rupp for the C.I.A. Nevertheless, he was found guilty and put on probation. Kelso promptly left the country (in violation of his probation) and spent the next three years in Europe and Costa Rica, he says, working for the agency. U.S. Customs confirmed that Kelso had worked from time to time as an informant for them. He was apparently important enough to earn an honorable mention in North's universe as well.

On August 26, 1986, North had scribbled, "1310 — Call from Rob O. Re: Kelso..." Under the note North had written the names and phone numbers of an assistant U.S. attorney, Bruce Black, and a U.S. Customs officer, both in Denver. Kelso served only a few months for the parole violation. Today, Kelso says he still does occasional work for the "intelligence community."

GLOBAL AIRWAYS AND INDIAN SPRINGS STATE BANK

In 1982 Global International Airways Corporation had a fleet of 14 jetliners and a crew of swashbuckling pilots who regaled one another with hair-raising stories of shadowy flights to remote airstrips in Central America and being paid with briefcases full of cash. On one such flight, crates marked with Red Cross stickers were opened by Costa Rican officials and found to contain 75-mm Chinese-made machine guns. Another shipment was simply marked "cabbages." The pilot who told the story laughed: "Right, cabbage and cabbage launchers."

Global was owned by Farhad Azima, an Iranian-born naturalized American. Azima began his airline in 1978 flying cattle to his former homeland, where his family had had close ties to the Shah.

But soon after setting up shop, Global was flying shipments for notorious C.I.A. rogue Edwin Wilson and his company, Egyptian-American Transport and Services Corporation (Eatsco). (That company's other associates included Thomas Clines, Ted Shackley, and Major General Richard Secord, who would each later play a starring role in the Iran-contra affair.) Eatsco hired Global to fly millions of dollars' worth of arms to Egypt after the Camp David accords were signed. (Another Eatsco founder, a former Egyptian military intelligence official name Hussein Salem, was later sentenced for overcharging the State Department by \$8 million for the shipments and using the money to fund secret arms deals, some of them with Libya). Wilson is serving a total sentence of 57 years for selling arms and explosives to Libya and for attempting to hire assassins to murder witnesses and prosecutors in these cases.

The Eatsco contract earned Global about \$100,000 per flight, and after Wilson's indictment Global had to find a new way to keep itself in business. That's when Azima showed up at the Indian Springs State Bank in Kansas City, Kansas. Indian Springs was a whore of a bank; money flowed out of its coffers into the pockets of a long list of mobsters and swindlers. One of the bank's chief officers, Anthony Russo, was a former attorney who had represented members of the Kansas City Civella mob family. Russo voluntarily relinquished his license in 1974 when he was convicted of conspiracy to promote bribery and prostitution. In 1981 he was a vice-president at Indian Springs. His job was to bring new business into the bank. "Tony could do it," a former bank official later recalled. "He'd tell someone to move their accounts to the bank and they'd do it."

The Civellas weren't the only notable recipients of loans; Farhad Azima also came to Indian Springs to borrow money. In addition, Azima was promptly appointed by the bank's president, Everett Lemaster, to Indian Springs's board of directors. Russo, in turn, became a paid "consultant" to Global.

Some of Indian Springs's money, which funded Global's planes, came from New York deposit broker Mario Renda, who poured tens of millions of dollars in union-pension-fund money (much of it from the Teamsters) into Indian Springs. An F.B.I. informant told law-enforcement authorities that Renda bragged about having worked with the late New York mob boss Paul Castellano. Renda was also an associate of Saudi arms dealer Adnan Khashoggi. (Renda was running his own multimillion-dollar scam at the bank for which he later went to jail.)

When federal banking regulators finally caught up with Indian Springs, they told Lemaster that unless he fired Russo and cleaned up the bank, they'd close it down. Lemaster complied and told everyone that the jig was up — Russo had to go; Global and the other had to repay their loans. A few days later, Lemaster died in a fiery car crash. Investigators ruled out the possibility of an accident and there was no indication that it was suicide. The cause of the crash has yet to be determined.

After Lemaster's death, regulators seized Indian Springs State Bank. Global then defaulted on its loans and filed for bankruptcy. Russo was indicted for tax evasion, having failed to report \$25,000 he'd received from Global. He explained in court that Global had been hired by the C.I.A. to fly Samuel Doe, at the time the new president of Liberia, on an around-the-world goodwill tour and Azima had asked him to be Doe's personal companion on the trip.

Russo was tried on the tax charge twice, both trials resulting in a hung jury. The charges were dismissed and the prosecutor in the case complained that Russo's use of the C.I.A.'s sensitive diplomatic agenda in his defense earned him more credibility with the juries than he deserved. Piling up more impressive details, Azima's testimony had to be postponed because he was scheduled to attend a dinner in Washington for major Republican donors.

The C.I.A. was more directly helpful to Azima when his own activities came under scrutiny. Shortly after then assistant U.S. attorney in Kansas City, Lloyd Monroe, opened an investigation into Azima's Indian Springs loans, the F.B.I. agents assigned to the case reported back to him that they'd been waved off by a higher authority: "Representatives of the C.I.A. confronted my agents and told them that Azima was off limits. They told the agents to tell me that Azima had been doing work for them and had a 'get out of jail free' card." Monroe dropped the investigation.

When Global filed for bankruptcy, it listed \$15 million in debts, including almost \$1 million owed to Indian Springs and \$367,000 to the Department of Defense. Even so, just days earlier Azima had made a flurry of last-minute campaign contributions, mostly to Republican candidates, including the "President's Dinner Committee."

Indian Springs wasn't the only financial institution to be left with an outstanding loan to an Azima airline. According to Federal Aviation Administration records, the now failed Republic Bank of Kansas City, Missouri, also lent money that had been secured by Azima's

old 707 aircraft, as did Utica National Bank and Trust Company of Tulsa, which lent more than \$6 million to another Azima company, Aviation Leasing Corporation. Utica failed in 1989. F.A.A. records show that Utica's loans to Azima were insufficiently collateralized. *The Houston Post* revealed earlier this year that the Sunbelt Savings and Loan of Dallas, Texas, was helped along the way to insolvency by a Global supplier, California-based Response Air, which kept itself in business with a \$19.5 million Sunbelt loan that was never repaid. (The collapse of Sunbelt Savings will cost taxpayers more than \$1.5 billion.)

After walking away from his Indian Springs loans, Azima turned his attention to a new airline. Race Airways, which he claims was owned by his brother. Iran-Contra investigators believe it was a Race 707 that delivered 23 tons of arms, including TOW missiles, to Iran as part of the secret arms-for-hostages deal. When the Iran-contra scandal broke, Azima slipped off to London, where he now lives. But he didn't lose his appetite for freight airlines. In February 1989 he purchased Buffalo Airways, a small cargo company based in Waco, Texas. Buffalo Airways had been in trouble since its incorporator, Dallas attorney Wordy Jack Thompson, was convicted in 1986 for receiving fraudulent loans from Empire Savings of Mesquite, Texas. Empire failed in 1984 at a loss to taxpayers of over \$400 million.

Houston Post reporter Pete Brewton discovered that Thompson had also incorporated Global Jet Sales, which did a lot of business with Response Air and another company called Parmax. Former Pentagon investigator Gene Wheaton told Brewton that he had tracked several C-130 aircraft with ties to these three companies to the Medellin drug cartel as well as the Drug Enforcement Agency and the C.I.A.

Finding Rupp's and Azima's operations sucking sustenance from two federally insured financial institutions that were about to fail could have been written off as just a coincidence, but we kept running into almost identical circumstances at other banks and thrifts: a bunch of shady characters, some with ties to organized crime as well as the C.I.A., pulling multimillion-dollar frauds. The money always disappeared, the institution almost always failed, and the C.I.A. didn't want anyone asking why.

When we looked into the failure of San Marino Savings and Loan in Southern California (cost to the tax-payers — \$400 million), we found a multimillion-dollar borrower-defaulter who had been working with members of the Los Angeles mob in an abortive contra arms deal.

The plan was to send submachine guns to an Indian reservation near Palm Springs and use the reservation's status as a sovereign nation as a cover. Richard Alvarez, a reservation adviser, objected to the arms deal. A few days later, he and two friends were found murdered in their beds. The murders were never solved. Homicide investigators told us that they ran into a wall of C.I.A., N.S.C., and F.B.I. agents.

At Flushing Federal Savings and Loan in Queens, New York, mob associate Mike Rapp, a graduate of the Federal Witness Protection Program, was using his new identity to extract millions. One of Rapp's lieutenants in the scheme bragged openly that he worked for the C.I.A. and made regular trips to Switzerland for Rapp. Also at Flushing — and working with New York money broker Mario Renda — was an attorney who, the C.I.A. has admitted, performed contract work for the agency in the 1960s. Investigators say that he was suspected of laundering large sums of cash through Flushing Savings for highly placed Haitian military officers who later played a key role in the overthrow of Baby Doc Duvalier.

Pete Brewton found similar patterns at other institutions, and sometimes ran into the same people. After a year-long investigation, he found evidence that 22 savings and loans — 16 of them in Texas — had been looted by individuals with ties to the C.I.A. or the mob — and more often than not, to both. Together the losses reach into the hundreds of millions of dollars.

The Christic Institute, a multi-faith, nonprofit organization based in Washington, D.C., is suing the C.I.A. and a long list of its alleged subcontractors for what the organization claims were illegal covert activities. (The institute's suit was dismissed with sanctions by a federal judge and the organization is now appealing.) The group's leader, attorney Dan Sheehan, told *Penthouse* that he speculates that defrauding federally insured financial institutions was one of the key ways in which the agency was funding its more controversial covert operations. Sheehan said that the agency used "linked financing schemes" to defraud banks and thrifts. Large deposits were placed at targeted institutions and management was instructed how and to whom the money was to be lent. The deposits, of course, were federally insured, so when the loans were not repaid, the deposits were not lost and could be used over again for another operation.

It sounds simple enough, but each time we tried to get our arms around one of these deals we found ourselves saddled

with the usual sleazy, unreliable sources. Their stories always had to be weighed against the possibility that they were just trying to explain why they'd been caught in the vault. One case, however, was a notable exception. In this instance, the agency strayed from its usual personality type and dragged an average, unwitting civilian into its scam.

Robert Maxwell, a banker in his mid-thirties, had just joined the First National Bank of Maryland in Baltimore as manager of the credit department for international banking. During his first week on the job, in 1983, a senior official at the bank asked Maxwell if he would handle the account of Associated Traders Corporation. A.T.C. was a C.I.A. front company, Maxwell was told, and the company needed certain bank services. Maxwell agreed to take the account and was cleared by the agency.

Over the next two years, Maxwell helped Associated Traders set up a complicated money trail through which the agency financed about \$20 million in arms shipments to Central America, Angola, and Afghanistan. As the deals got more complex, Maxwell began to get nervous. He suspected that the transactions did not have State Department approval and therefore might be illegal. Maxwell was also anxious about the fact that one of the bank officers had arranged for only his name to be on the documentation. "The way the deals were being handled, it appeared as though I was working for Associated Traders," Maxwell told us. "And that wasn't the case at all."

Maxwell asked that his name be taken off the accounts. He also explained to his supervisors why he thought the A.T.C. deals were illegal. Then, Maxwell charged, bank officials began a program of harassment. This only heightened his suspicions and he demanded that the bank provide written authorization for transactions already completed. He was ignored. Maxwell said that then he began getting threatening messages from certain bank officers and he feared for his and his family's safety.

In August 1985 Maxwell resigned. A few weeks later, he had a nervous breakdown. When he recovered, he went looking for a lawyer, but no one would touch the case. Everyone thought he was crazy. The syndicated columnist Jack Anderson exposed Associated Traders as a C.I.A. front. The company immediately folded its tent and dissolved. Maxwell found a lawyer and has filed a \$4 million civil suit against the bank, the C.I.A., and Associated Traders.

Both the C.I.A. and bank officials have refused to comment on the case. Maxwell is now a bartender in Pennsyl-

vania, where he lives quietly with his wife and children. "It is very clear he will never go back into banking," says his attorney.

Deregulation of financial institutions during the 1980s created enough havoc and confusion to cover for just about any kind of scam. The Justice Department now estimates that drug dealers alone were probably able to safely launder billions of dollars through savings and loans completely undetected. And when the C.I.A. wanted to run guns or have money laundered or stolen, they turned to the kind of people who do such things for a living — psychopaths, crooks, and the mob. Wasn't that risky? Not really. In fact, though it may have resulted in some "spoilage" (money stolen from the operation by the contractor), it actually lessened the chance of "blow-back" — agency exposure. The reason is creditability, or more to the point, lack of creditability. Heinrich Rupp, for example, was a truly "incredible" guy. The agency had to have known he was pulling a \$2 million scam at Aurora Bank. Yet they did nothing. Letting Rupp get caught and prosecuted as a common thief finished his agency career. His tall tales of being a Nazi fighter pilot at age 14 and his habit of flashing gold bars and wads of cash around like a fool helped, too.

"The agency likes things that way," a retired C.I.A. covert-operations officer told *Penthouse*. "Yeah, the wilder and crazier and sillier the story, the more they like it. The agency indulges people to come up with that. It's the best defense."

Would the C.I.A. look the other way if it knew one of its contractors was doing something illegal? we asked another former C.I.A. covert officer. "The C.I.A. would not only want to continue to use their services, but they would not want to bring attention to that person," he told us. "They would want to keep it out of the public. They may want to use that person again." Former C.I.A. agent David MacMichael agrees. "Sometimes these individuals were handling deposits on a covert basis, they could assume a degree of immunity that allowed them to act with more than the ordinary degree of recklessness." MacMichael said that once a contractor is on board, the agency actually allows them to get into a position of committing an illegal act to get them "on the hook." Then when an operation blows up, the contractor is cut loose. "When a contractor gets caught, all their 'friends' disappear. It happens over and over again," MacMichael added.

On August 1, 1989, sitting in his cell at Fort Leavenworth, Kansas, Heinrich Rupp typed a three-page letter to Presi-

dent George Bush. In the upper-right-hand corner, he attached a copy of his membership card for the Association of Former Intelligence officers, issued in August 1988.

Mr. President, I am writing you as the president and commander in chief, and as a fellow member of the Association of Former Intelligence Officer. I am greatly disturbed that my adherence to the same oath which you once took have [sic] resulted in this kind of treatment. I am further appalled that I have received no kind of relief whatsoever

in my case....I have given all this, and nearly 30 years of service to my chosen country....I am now 60 years old and languishing in a miserable pest-hole full of drug dealers and other low-life criminal scum.

But Rupp ended his letter with reassurance to the President that if this be his fate, so be it: *For the protection of this country and the ideals which I have been sworn to uphold, my lips have been and will be sealed. I remain, yours in faithful service, Heinrich Rupp, Scorpio 688.*****

PENTHOUSE, NOVEMBER 1990

Urgent Attention

8/2/93 #1 HATONN

URGENT ATTENTION

The following message was gotten to us by Ray Renick and I believe it important that you have the information. You are on borrowed time, readers, and this is not going to be a very happy paper—BUT, YES, AS YOU SEE—YOU WILL BE ABLE TO HELP IN SOME AREAS OF NEED. This is not one of them, however, for it is but prophecy which by its removal from your prior access, at all costs—is verification of its general content.

Quoting: There is a man who now lives in Fullerton, California named Dumidru

Duduman. He is a Romanian. He was deported FROM Romania for running Bibles into Russia and he spent about 17 years in jail being tortured and everything else imaginable. They finally deported him and then sent him to Los Angeles. The reason that they sent him to L.A. is because he said that he has a message that he has to get to the people and it's the same message that was in last week's paper by the "Parowan Prophet". He has the same message. There's a book called *Through the Fire* but you cannot get it. END QUOTING

Our "staff" is following up and as we have information from this person, just as with Leland's projections, we will share them right up front.

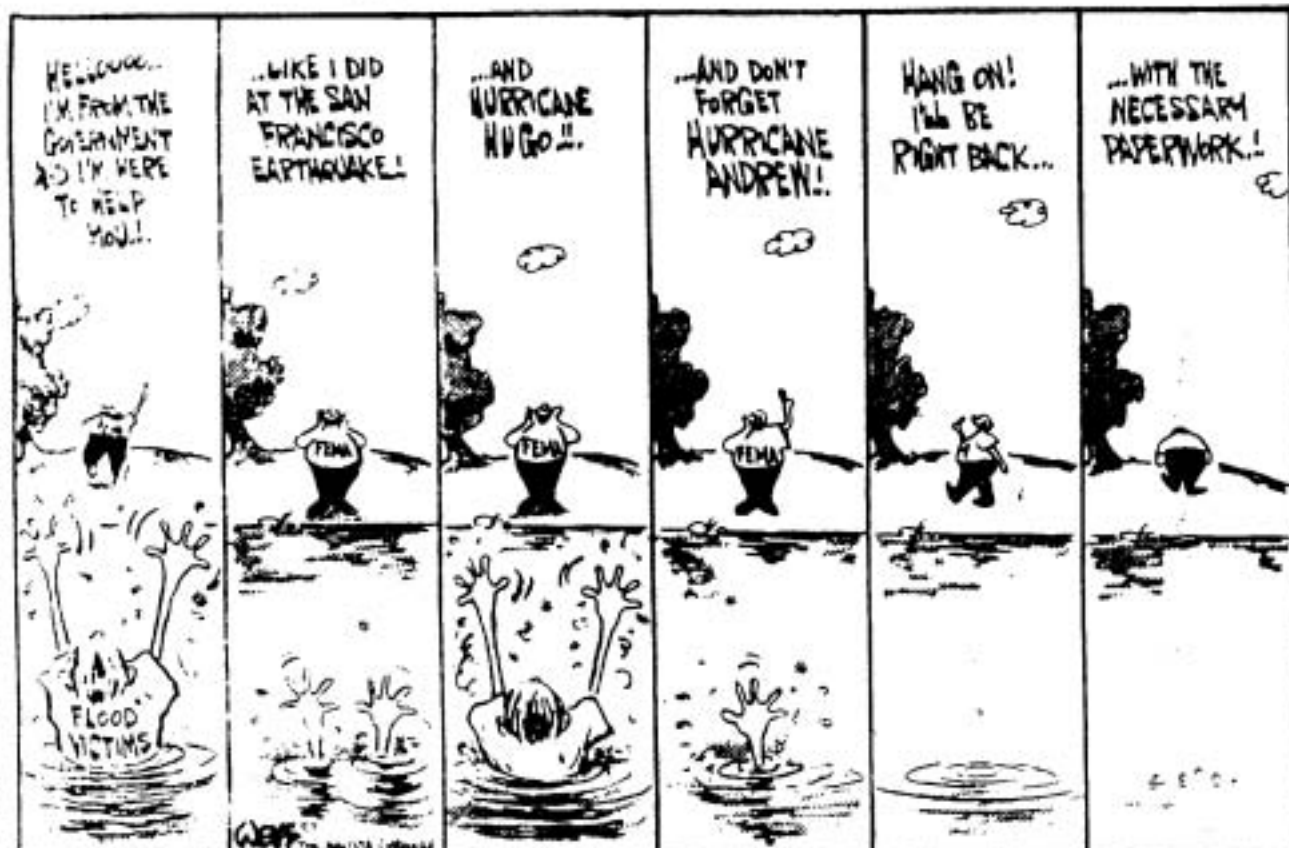

World's Largest Treasure Hunt

(Continued from page 1)

been and now I see that great impact can be brought into play IF YOU-THE-PEOPLE want this badly enough.

Please don't sit and count your chickens—the eggs are "only" laid thus far—and YOU don't have a right to that which others have earned and labored long in the vineyards to acquire. However, the laborers in the vineyards now offer to SHARE with you as a citizenry—at least, of the USA. They will also "share" with us as a group of writers efforting to bring the word, projects and truth to you-the-people. Yes indeed, it can be "both" ways in this instance.

I would remind ones involved, however, that I am a "Host" and even if various ones on my own "side" don't quite understand me or my mission—THE ENEMY CERTAINLY DOES!

The Bush administration and "his" CIA have ripped-off, bungled, broken agreements and even have managed to kill, wipe-out, incarcerate and generally "break" participants who made agreements in GOOD FAITH, contracted in GOOD FAITH and worked diligently AND PRODUCED that which was asked. Then came the greedy mongrels and froze the "commissions", accused the participants of illegal actions in order to maintain the frozen funds, etc. Among them who have been badly used will be names like Marcos, Khashoggi, Hussein (Both), and others of International fame which we will, for now, leave unnamed. Let us just say that the main player in OUR game is among the three richest men in the world! Is he a GODLY icon? Please, readers! This PERSON is wholly AGAINST the Committee of 300 and all tools thereof—in other words, the idiots in power ripped-off the WRONG person. This is good—for us, and hopefully, for you. Actions were in genuine intent of legal transactions—the head honchos just plainly got greedy through Citibank, the Federal Reserve, BCCI, BNL, etc. The unfolding of all of this will be most interesting. This is NOT, however, my intent of this day. I am focused on giving

you enough material to recognize the truth so you can start your "contacting" and we will fill in the parts as we go along.

Bush and Buddies are the culprits with their fingers through the Committee of 300 and the International Banker's Cartel. However, Clinton NOW sits in the hot-seat of deciding WHAT TO DO ABOUT IT! I am told by little mice-mouths into my inner "ear" that a "trade-off" for releasing the massive amounts of "commission" funds from frozen accounts in the Fed Banks and International Monetary Fund banks—especially the BIS (Bank of International Settlements)—IS TO FULLY FUND (WITHOUT NEED OF TAXATION OF THE PEOPLE) THE NEW HEALTH PLAN WHICH CAN THEN AFFORD TO COVER EVERYBODY FAIRLY. Indeed, chelas, THERE IS THAT MUCH MONEY IN POINT.

This is WHY, however, the efforts are afoot to pull down all CURRENCY EVERYWHERE! Then, your American dollar can be dealt with and recalled and you have lost any control whatsoever and all value of all things will be set by the bastard controllers. The "hope" of the Elite is that you will not pressure IN TIME to stop the ball from bowling all of you over! Clinton COULD change the course of the world—if he so chose to do so. Will he? Unlikely! However, this is only ONE pool in the tidelands and he just MAY if the gratuities are suitable—and ONE might WELL BE to stay nicely alive and well. Would this be a threat from the "other" side? Well, I don't know but some people are ending up very dead without reasonable explanation from Belgium's King in Spain to a lawyer-friend of Clinton. The opposing factions in this game are very, very powerful and not JUST IN MONEY DEALS—so to oppose them is very dangerous, I am given to understand.

Monies earned and promised were, by Administrative ORDER, frozen with full cooperation and action by BANKS. I suggest you be prepared to barrage the White House with your cards, calls, FAXes and letters, "you-the-people". If you get nothing more—you WILL get attention. And, for

every letter you send to Washington—please send a copy to Ross Perot! In addition, mention, please, that the CONTACT sent you as a customer. Thank you.

Now we will just start laying out background. I shall continue to protect and keep private personal names and information which has as of yet—not been made generally public. Since my scribe doesn't know any of them, I shall have to delete some which otherwise would be suitable for "press" but permission is not obtained thus far. Let us go with what we can at this point and follow-on as we gather information. CAN YOU MAKE A DIFFERENCE? YES—A MASSIVE DIFFERENCE! MASSIVE!!

It would seem, Dharma, that the best way to approach this is to give the press articles and then the lengthy write-up about the CIA *Cash and Carry* from the magazine.

This will be tedious and the paper is already at great "overrun" and also without our Chief Editor—so please bear with we humble servants and overlook that which is observed to be somewhat "incorrect" in structure.

WORLD'S LARGEST TREASURE HUNT

\$1.5 TRILLION, an Atlanta investment firm, murder and a global investigation: By Emory Thomas Jr., *Atlanta Business Chronicle* Jan. 3, 1992.

QUOTE:

In a crowded suburban Holiday Inn meeting room one evening last summer, approximately 100 Atlantans waited eagerly for Jim Gilmore to begin speaking.

At 7:30 sharp, the nattily dressed, silver-haired Gilmore stepped to the podium, holding up a box of chocolates wrapped in gold foil.

"I know why you're here," he declared, referring to the mock bullion bars. "This is why you're here."

Indeed, most of the attendees that day

had come for a single purpose: to find out how soon they would be rich. Rich, in fact, beyond their wildest dreams.

For months now, Gilmore—a self-proclaimed management consultant who lives in Boswell—has held himself up as the leader of a byzantine international legal battle funded by a burgeoning group of individual investors. The battle is being waged to recover a mammoth fortune allegedly made during the 1960s by representatives of a mysterious Atlanta-based company called SBC Chorco.

The total take, according to Gilmore: \$1.5 trillion, a sum that well exceeds the United States government's yearly budget.

The stakes got even higher in July. One of the principles of SBC Chorco was found strangled to death, along with his wife, beside a rural highway in southeast France.

Outrageous as it may seem, the investment scheme has attracted what appears to be thousands of participants—including some respected Atlanta business people.

[H: As we offer the articles, please realize that most papers do not do as do we with timed, dated writings (every time we write). Therefore, as things are FAXed about and articles are "clipped" it is often that even if you have the name of the publication you may not have accurate dating. We will give you the nearest date appearing to be applicable from the headings of the FAX printout, but if you go searching for these, please check on "both" sides of the dateline.]

ATLANTA BUSINESS CHRONICLE (Dec. 13, 1992):

SEC DIGS DEEPER INTOTRILLION-DOLLAR SCHEME

The Securities and Exchange Commission continues to close in on the instigators of what may be one of the largest and most intriguing get-rich-quick scams in U.S. history.

As reported in last week's *Chronicle*, the SEC obtained a temporary restraining order against Sam S. Brown Jr. and James B. Gilmore—the main characters in an alleged plot to defraud thousands of investors by selling them stakes in a fortune purportedly worth \$1.5 trillion. The fortune was said to have been made by Leslie Chorlton, the victim of a gruesome mob-style murder in France in July 1991.

On Oct. 16, the restraining order became a preliminary injunction. And five days later, the Commission filed more documents that named additional defendants and sought to retrieve more than \$1 million held in overseas accounts.

According to the SEC, Gilmore last month began wiring much of his allegedly ill-gotten booty to accounts in foreign countries. SEC documents assert that he set up an account at The Enterprise Bank in

Dunwoody and then transferred \$583,000 to an account in Liberia, \$200,000 to an attorney named Clive Franks in Scotland, another \$200,000 to Amay Associates Ltd. in Switzerland, and an additional \$45,000 to accounts held by "other apparently related persons".

The newly listed defendants are Franks, a lawyer with Macadam & Brown; Douglas G. Gilmore, "believed to be" James Gilmore's brother, Amay Associates Ltd., a Geneva Corp; and two individuals, Ami Simon and Josef Covals, "who are believed to be in Australia."

Says one SEC spokesman, "We're really still at the beginning of this thing."

December 14, 1992

BOMBAY STOCKS SCANDAL CLAIMS CITIBANK CHIEF

Citibank of the US has transferred the chief of its Indian investment banking operations following intense criticism of the bank's role in the Rs35bn (816m Pounds) securities market scandal, writes Shiraz Sidhva in New Delhi.

Mr. A.S. Thiyagarajan's departure for New York means the four foreign banks most active in the securities market have now lost their top officials since the scandal erupted in April.

All four—Citibank, US owned Bank of America, Australia's ANZ Grindlays and Standard Chartered Bank of the UK—were criticized by the Reserve Bank of India, the central bank, and by a parliamentary committee investigating the scandal.

Meanwhile, Mr. Bob Edgar, ANZ Grindlays' chief executive for India, is leaving this week after two years in India.

The Central Bureau of Investigation yesterday arrested Mr. Binoy Jacob, a non-resident businessman, for his alleged involvement in the receipt of illegal commission payments from foreign companies.

DUTCH BANKER TO HEAD GOVERNORS

FINANCIAL TIMES, Wed., Dec. 9, 1992: The president of the Dutch central bank, Mr. Wim Duisenberg, has been elected chairman of the committee of European Community central bank governors, a body regarded as a forerunner of the mooted EC central bank, writes Ronald Van de Krol in Amsterdam.

Mr. Duisenberg, 57, the head of the Netherlands' central bank for nearly 11 years, will succeed Mr. Erik Hoffmeyer of Denmark who was named acting chairman of the committee last year after Mr. Karl

Otto Pohl, the then president of the Bundesbank, resigned.

The appointment of Mr. Duisenberg is for one year only, but it will give heart to campaigners in Amsterdam's financial community who are trying to promote the Dutch capital as the site of the European central bank.

However, Amsterdam's chances are still considered slim unless there is a stalemate between Germany, Britain and France, enabling the Netherlands to emerge as a compromise candidate.

Mr. Duisenberg, who was recently named Central Banker of the Year by *Euromoney* magazine, brings a wealth of international experience to his new job. **He is a past president of the BANK FOR INTERNATIONAL SETTLEMENTS IN BASLE.** He began his career in the late 1960s as a staff member of the International Monetary Fund in Washington after completing a degree in economics at the University of Groningen in the Netherlands.

A former Dutch finance minister, Mr. Duisenberg is a prominent member of the Dutch Labour party and a former Labour member of parliament. He had a three-year stint as a director of Rabobank, the large Dutch co-operative bank.

The Dutch central bank, like the German Bundesbank, is independent of domestic politics, and Mr. Duisenberg has repeatedly said that this is a precondition for the proper functioning of any European central bank.

LIQUIDATORS OF BCCI FILE LAWSUIT

Dec. 14, 1992: By Alan Friedman in New York and Richard Donkin in London: The Liquidators of the Bank of Credit and Commerce International have filed a \$10.5 bn civil lawsuit against Sheik Khalid bin Mahfouz former head of National Commercial Bank of Saudi Arabia who was indicted in the US last July on BCCI-related fraud charges.

The suit, against both Sheikh Khalid and the bank itself, is unusual both in its size and because it means an embarrassing legal action is being brought against a leading banker close to the Saudi royal family.

Under US racketeering laws, the actual damages to be awarded if the lawsuit succeeds could be trebled to more than **\$30 bn**. Sheikh Khalid has denied all charges.

The liquidators allege in the suit—filed in the US, UK, Jersey, Luxembourg and Switzerland—that Sheikh Khalid broke US laws by engaging in racketeering and fraud. The suit seeks to freeze

the assets of Sheikh Khalid and the Saudi bank in each country.

The US Federal Reserve last summer levied a \$170m penalty against Sheikh Khalid. [H: Boy, I bet that made Sir Khalid happy! Well, maybe he will get a bit happier as time moves on. I think you will see now, however, how it is that other actors such as Clark Clifford, Altman and other big cheeze US wheelers and dealers DIDN'T GET MORE THAN A TINY, TINY SLAP ON THEIR WRISTS ALL THE WHILE THE JUDGE WAS "WINKING" AT THEM. IT WILL, IN TIME, ALSO MAKE CLEAR WHY ONE SUCH AS KEATING IS TAKING THE HOT-SEAT FOR THE BASTARDS WHO DID THE ACTUAL JOB—HE ACTUALLY DID NOTHING ILLEGAL. I WOULD GUESS THAT MR. KEATING WOULD SPOIL THE STEW IF HE EVER GOT BRAVE ENOUGH TO BLOW THE WHISTLE AND COULD GET FREE LONG ENOUGH TO DO SO—PRIOR TO THE LOBOTOMY!] It also ordered the National Commercial Bank of Saudi Arabia to shut down its New York branch.

In Washington, Judge Joyce Green of the district court has issued a temporary order that stops Sheikh Khalid from transferring any of his US assets out of the country.

In London, Mr. Dennis Norman, acting general manager of National Commercial Bank's UK operations, confirmed the bank had received a restraining order on Sheikh Khalid's UK assets. "We are very shocked about the action," he said.

MR. PRESIDENT

Next, we will offer a letter to Hon. George W. Bush which gives great credence to this "story":

February 10th 1992

The White House

One Pennsylvania Avenue

Washington, DC

Attention: Hon. George W. Bush, President of the United States of America.

Mr. President,

May we first of all take an opportunity to congratulate you on a very memorable first term in office.

We are a mixture of Republicans and Democrats, but we are all very proud as Americans to be witness to probably the finest period, in history, and hopefully a time in human terms when wars are only to be fought in the boardrooms of businesses and banks.

We are respectfully writing to you, to request your help and your interference as head of state in a situation that we, know you to be very familiar with.

This request is made of you, on behalf of all of the persons named on the attached

list-addendum A., and all those other persons and businesses involved in the matter at hand, whose names are not on said list, but are deeply involved and concerned on the outcome of our request. [H: We are unable to print the listing.]

A synopsis of all the events to date is now stated so that you are better versed in your knowledge of the matter from our position in the affair.

Back in the late seventies, it was decided to exercise many large 'Arbitrage' financial transactions, to ease the burden and debt of our country.

To date there have been four major transactions, with another one presently underway at this time.

We have named them basically 1, 2, 3, and 4, but they also carry some codename for identification among brokers, for ease of recognition as follows: No. 3 is called 'the Japanese deal or Blue Streak'; No. 4 is known as 'the Greek deal' or 'the Hammer', but they all, carry proper transaction code numbers which are listed on Addendum B.

The four major arbitrages, also encompassed many lesser deals that were essential to the success of the main four, and the Financial brokers, lawyers and businesses involved in total during this time numbered in the hundreds.

To date, according to all records, not one individual, or business has received payment of commissions or even any recompense for the monies that they paid out in order for the arbitrages to succeed.

In fact, in terms of human misery, the toll has been extremely and unnecessarily high.

Many persons have seen their businesses destroyed financially to a point where individual families have broken up due to the pressure of the past several years, and there are recorded cases, of severe health and heart problems, one where the person has died.

We are all fully aware of the details and nature of what can only be described as Grand larceny and Fraud created and/or condoned by top officials and senior members of your administration, aided and abetted by the Justice Department, the Treasury Department and the Department of the Comptroller of Currency, the Federal Reserve and the Central Intelligence Agency, not to mention others.

The latter is our target of concern, because the CIA have been the main instrument used for the purpose of working in accord with all of the main banks involved in the transactions, with all monies we have earned rightfully as commissions for our work done, being now in the hands of, and under the full control of the CIA.

There have been attempts made by many persons seeking payment, but their efforts have failed due to their singular

evidence being insufficient to place litigation in the courts.

One such case was filed in Washington DC, last year, but was acted upon by the Judge as frivolous, due to insufficient evidence.

That has now changed drastically.

It has taken almost 4 years, but now communication with all people concerned with the four arbitrage transactions, has culminated and amassed an almost complete documented trail of the transactions in the amount of well over 250,000 separate pages of correspondence & other pertinent detailed documents outlining the whole situation.

Those documents are in a sanctuary, and also copied on disc, so we can access them at any time necessary.

The Arbitrages, which involved several Trillion dollars of 7 1/2%-20 year Promissory Bank Notes (PBN's) involved several countries, i.e., Japan, Great Britain, France, Germany, etc., not to mention several international personages, involved both on the Collateral side and also on the funding side, such as, Prince Feisal & the Rothschilds of Paris.

Major international banking entities have also taken part in these transactions and also given their complete assistance to the CIA, i.e., Barclays PLC and London, AMRD, Deutsche, First Chicago, SBC, Continental, and Standard Chartered, just to mention a few as well as Hong Kong Shanghai, in Asia. There were also Japanese banks and others from many countries including our own United States.

There are brokers and businesses involved in our request from many countries such as Canada, Holland, Singapore, Australia, England & Switzerland, but all wish to see an end to what has gone on.

We are all aware of your knowledge of the 'company' and its role in the diversion of our monies, to its own uses, but we will not make any further mention of that, as a previous Director of that agency, you have full knowledge of the internal workings of the CIA.

We have been very fortunate over the past few years to receive help from persons on the 'inside' who have monitored the movement to the various accounts, of our funds, and it has also enabled us to sort out good reports from 'false smokescreen' monitoring.

Mr. President, we, all of us, very respectfully ask for your support and assistance, in the arrangements to be made at the earliest time for a meeting to be held between chosen members representing those on our side, and members of the Government and/or its agencies, who have responsibility in this matter.

Said meeting to be held in strict secrecy in a place to be further arranged and agreed upon.

The many billions of dollars now 'frozen' in escrow in New York and the billions in Europe, that are transferred almost daily from one account to the other, all relating to our commissions, would make a great contribution to the economy of this country, were they to be released by negotiation.

The larger amounts that would be available to your office would put the nation back on its feet financially, not to mention, the large boost also from recipients of commissions, due to their own investments and spending.

We could go into far more detail than we have done at this time but given the fact that we know that the administration is fully aware of the basis and reason for this documentation, we do not feel that further mention is necessary.

We want to give our assurance, that we have no intention of taking any further steps to retrieve our monies providing we can sit down in an atmosphere of integrity and responsibility, and reach a fair and amicable settlement to our situation.

We are requesting your help in confidence, to attain some form of a just payment of the commissions we are all rightfully entitled to.

There are those persons who feel strongly that we should take this matter to the House and the Senate and by notifying each individual member of Congress, with a complete detailed dossier of events, lobby for a Congressional investigation, and ultimately a Hearing.

We do not agree to that form of pressure, although we would take a step as such, if there was no alternative, but we believe strongly, that a quiet negotiated settlement, in strictest secrecy, is in our opinion the best way to achieve our goal.

It would be too devastating an action in this election year.

In the attached addendums we have placed in order of contact at your choice, the names and addresses of persons and/or firms, whom we would ask you to contact with any reply to this request either by notifying one, or all of those as named.

In that way we are certain that all persons involved in the four transactions, will be fully informed of any pending actions.

A complete list of all persons and businesses who took part in even a small way in one or more of the four arbitrages, are now compiled in a master list, which can be made available at any time in the future, if so requested.

Addendum B lists further information, re other names or numbers given to the four transactions, and also lists the names of key persons, who are allegedly involved with the named agencies, and Government departments, in the withholding of funds payable to persons on the master list.

Again, we must reiterate, that every

name listed is for the sole purpose of information only, as known to those within our closed circle, and is not for any other purpose or intention.

Mr. President,

We are sincerely hoping, that you will be able to agree to this earnest request for help and assistance, and put an end to all of the anguish that is now prevailing.

Certainly, no one among the persons on this side will ever give up the fight, to obtain what is rightly theirs, no matter what cost is involved.

Our very sincere and respectful wishes for good health, happiness to yourself and our first Lady, and good luck in the coming year of the election.

Typed for and on behalf of the persons and entities named on the Addendum A, after consultation and discussion with key members of that list, on the content of the matters herein documented, which appertains to all four transactions aforementioned.

SIGNED but not revealed.

(Addendum's unavailable for press. However, names have been checked and are valid.)

8/2/93 #2 HATONN

ANTI-BLACKMAIL

This will be a continuation of documentation in the matter of the "arbitrage" frozen funds. In the instance of a major player, we shall refer to this one as "Rosebud".

The question from you readers should be: "Come on Ghost Writer, I'm not interested in health insurance—I think the medical community is trying to kill us anyway!" So, when you consider this much return of money to those who aren't able to get it "on their own"—perhaps "we-the-people" SHOULD ASK FOR A BIT MORE—LIKE ENOUGH TO COVER THE COST OF THE MASSIVE DESTRUCTION OF THE PLANNED AND DELIBERATELY ORCHESTRATED FLOODS ALONG THE MISSISSIPPI. The several billions (if recovered) would not be more than a pittance to the rightful "receivers". Perhaps they would be kind enough, IF YOU DO THIS FOR THEM, to put aside a few more little sums to cover part of the incredible emergency disaster relief from the big earthquakes ALSO PLANNED BEFORE THIS FALL.

Oh, you think Lizzie Dole and the Red Cross will pick up more donations and cover it? Forget it—the Doles were on the "dole" from the fallout of these buried transactions—like as in "payoff"! I think these receivers would be graciously glad to help you **IF YOU HELP THEM**. Perhaps they would even contribute a bit of support to *CONTACT* so you can ALL get a bit more

information as we can get "help" and afford stamps! I believe I would be most happy to help with such projects! GOD ALWAYS WINS, MY FRIENDS—AS TIME AND PROPER SEQUENCE PRESENTS ITSELF. IF NOT, THEN YOU WILL SEE THAT THE ADVERSARY WILL LOSE—EITHER WAY! Our major purpose at this time of upstart from total inertia is to keep everyone valid and in honest and Godly intent and reward—alive, well and in action. The "chariot" rides can come later in the "fun phase"—it is still labor time.

Is this considered "blackmail"? No, I consider it "light"-mail. In exchange for service we expect worthy deeds and promises kept. It is not nice to effort to fool either Mother Nature or the Chariot Drivers of God. Hold my hand and I'll take you "over there"—cross God, my friends, and "I" shall "send" you "there"! God's people pray to HIM for help and HE sends US. We will see to His instructions—may you walk with us and not against us for in the giving in goodness the promise is that ye shall receive in goodness "for all the days of your lives". Use MY people badly and you shall feel the sting of the scorpion for the remainder of your days upon the Earth. So be it.

I would think you might just take stock of that which has happened with just a tiny two or three who claimed God as their calling and then turned with the bastard thieves into the camp of George Green—just as a tiny "for instance"—and they did unto self for we only offered every opportunity to return unto the security of the "fold". Mr. Green is in dire straits—with evidence piling against him in heaps and gobs daily. Desiree is as miserable as she has ever thought of being in her entire lifetimes—perhaps the worst fear realized—to have little or no MONEY expectations in the circle she attends. John Schroepfer is in an institution shackled by laws brought down against him from his estranged wife who has deserted him—with the assets of the marriage and all value except that which is in the Institute under John's corporation. He is but a pawn—having been deliberately and badly used by those ones. At the proper time for greatest merit—he shall be returned to wholeness in healing. Another just underwent immediate surgery for CANCER—after becoming all but debilitated—and this one was not beligerent—only confused as to direction. NO charges pressed against him or separation asked nor given (but in "guilt" ones will always separate themselves). As to the other, it is most difficult for he is being stung daily by the worst fire-ant of all—an emissary of George Green moved into his nest without recourse unto the strength which sustains! Do WE do this? NO, God ALLOWS—and YOU do unto self whatever ye find worthy of your actions. Would it not be nicer and easier just to drop the war, ask

reentry and turn unto the task of GOD which is at hand? So be it.

I want to send Coleman a message, please. There is another opportunity to make rewards of great abundance from the *COMMITTEE OF 300*. There is a group in Japan who wish to print and distribute your book(s). We forwarded that information to your address of WIR—we trust you got it. Now, today, comes another offer from the other direction—we shall also send it to your WIR address. We have no desire to see you fail to thrive—what you did (do) or claim is none of our business—however, since the “skip-out” of one George Green from his regular offices and dwelling in Carson City—we do not know where he is in Bozeman, Montana so mail being forwarded TO US is going to be forwarded to those who seem to be next suitable for same. Since these two things deal solely with the books of Dr. Coleman—we shall forward them to same. Further, I, Hatonn, intend to help him sell a zillion MORE! WE did not print that book for gain for selves—it was to allow income for the Colemans AND GET THE INFORMATION DISTRIBUTED TO THE PEOPLE! It is coming along nicely, John. When you weary of your traitor connections—perhaps you might want to consider a worthy path—sans ego. We WILL get our job done, you must know!

So, let us continue with the information in point:

ROSEBUD

The following is from “Rosebud” to (blanked out).

May 25, 1992

....Enclosed is a sample of a map and/or graph that I need to supply to the court reference to the settlement of Rosebud. (See page 51) I will put this in with the documents that have been furnished to me. The map does two things: (1) It shows your own personal opinion of how you fit into the transaction. (2) It helps the court to understand the transaction from your point of view instead of trying to sort through all those documents.

The sample enclosed is one broker’s point of view as to how he saw the transaction. I do not expect the brokers to all agree on how the deal was done.

I believe this can be tied back to two judgements that have already been obtained.

Let’s try to wrap this up.

Thank you,
Rosebud

[H: I ask that the chart (map) be included in the press as is. This is not quite accurate but as far as information

was understood by the makers of the chart—it is inclusively appropriate.]

Next is a copy of an action in District Court, District of Columbia No. 91 1599. Filed June 28, 1991 with the Clerk, U.S. District Court, District of Columbia

[H: This is by no means all that is going on in the legal chambers—but this is public record by its filing and therefore no damage can be brought on the Plaintiffs by this publication. It will give you the subject of the cases in point. It will give you ones enough names to do your checking, also.]

Plaintiffs:
CLEO K. HANSON
680 East 4750 S.
Ogden, Utah 84403
RICHARD M. KILBANY
1804 Northwood Drive
Clearwater, Florida 34624
JAMES F. CRIGLER
2131 68TH Avenue South
St. Petersburg, Florida 33721.

vs.

ALAN GREENSPAN
Chairman, Board of Governors
of the Federal Reserve System
2000 Constitution Avenue, N.W.
Washington, D.C. 20551
WAYNE D. ANGELL
Member, Board of Governors
Federal Reserve System
2000 Constitution Avenue, N.W.
Washington, D.C. 20551
EDWARD W. KELLY, JR.
Member, Board of Governors
Federal Reserve System
2000 Constitution Avenue, N.W.
Washington, D.C. 20551
JOHN P. LAWARE
Member, Board of Governors
Federal Reserve System
2000 Constitution Avenue, N.W.
Washington, D.C. 20551
DAVID W. MULLINS, JR.
Member, Board of Governors
Federal Reserve System
2000 Constitution Avenue, N.W.
Washington, D.C. 20551
NICHOLAS F. BRADY
Secretary of the Treasury
United States Department
of the Treasury
1500 Pennsylvania Avenue, N.W.
Washington, D.C. 20220
CHASE MANHATTAN BANK
Rockefeller Plaza
New York, New York
MARINE MIDLAND BANK
Manhattan
New York, New York
MARINE MIDLAND BANK

One Marine Center
Buffalo, New York 14203
CHASE MANHATTAN BANK OF
FLORIDA
28500 U.S. 19 North
Clearwater, Florida
BANK OF BOSTON
100 Federal Street
Boston, Massachusetts
MID-ATLANTIC NATIONAL BANK
Brick Church Office
Newark, New Jersey
KEY BANK
42481 Washington Boulevard
Ogden, Utah
MORGAN GUARANTY TRUST
Manhattan
New York, New York

(Defendants)

COMPLAINT
STATEMENT OF JURISDICTION

Jurisdiction is founded upon diversity of citizenship and amount.

Plaintiff Cleo K. Hanson is a citizen and resident of the State of Utah; plaintiff James F. Crigler is a citizen and resident of the State of Florida; and plaintiff Richard M. Kilbany is a citizen and resident of the State of Florida. Defendants Alan Greenspan, Wayne D. Angell, Edward W. Kelly, Jr., H. Robert Heller, John P. LaWare, and David W. Mullins, Jr. are all members of the Board of Governors of the Federal Reserve System conducting business at 2000 Constitution Avenue, N.W., Washington, D.C. Defendant Nicholas F. Brady is Secretary of the Treasury of the United States, an Agency of the United States having its principal place of business at 1500 Pennsylvania Avenue, N.W., Washington, D.C. Defendant Chase Manhattan Bank, through a corporate affiliate, conducts business in Washington, D.C. as well as in the State of New York. It is a national bank and a member of the Federal Reserve System. Defendants Marine Midland Bank and Morgan Guaranty Trust conduct business in the State of New York and are national banks and members of the Federal Reserve System. Mid-Atlantic National Bank of Newark, New Jersey, Key Bank of Ogden, Utah, Chase Manhattan Bank of Florida, Bank of Boston, and Marine Midland Bank are all national banks and members of the Federal Reserve System; however, each bank conducts business in the states indicated above where its principal office is located: New Jersey, Utah, Massachusetts, Florida and New York.

The matter in controversy exceeds the sum of ten thousand dollars (\$10,000), exclusive of interest and costs.

Jurisdiction is founded upon the existence of a Federal question and the amount in controversy. Thus action arises under

Sections 1331, 1337 and 1348 of Title 28 United States Code, the National Banking Act (Title 12 United States Code), the Federal Reserve Act of December 23, 1913, and the Regulations of the United States Treasury Department and the Regulations of the Federal Reserve Board. The matter in controversy **EXCEEDS** the sum of ten thousand dollars (\$10,000), exclusive of interest and costs.

STATEMENT OF CLAIM

1. Each of the three plaintiffs, Cleo K. Hanson, Richard M. Kilbany and James F. Crigler, has rendered valuable services in arranging the purchase and sale of credit instruments in one or more international transactions. As compensation for such services, the principals to the transaction have contractually agreed to deposit and set aside assets consisting of cash and United States Government securities in special custodial accounts in various United States national banks that are members of the Federal Reserve System.

2. In accordance with such compensation contracts, assets have in fact been deposited and set aside in various banking institutions (including but not necessarily limited to the defendants named herein) in special custodial accounts in the names and for the accounts of the three plaintiffs.

3. Based upon information obtained informally from the Federal Reserve Board, and upon information and belief, plaintiffs allege that the Chairman and Comptroller of the Federal Reserve Board on September 28, 1990 authorized the settlement, release and distribution of the assets deposited in all of the above-described custodial accounts. This matter has been identified by the Federal Reserve Board as Code 308 F.S.

4. For reasons not known to plaintiffs, the Federal Reserve Board, the United States Treasury Department and the various defendants banks have refused to release and distribute to the plaintiffs the assets deposited and set aside in their individual custodial accounts.

5. By letters dated April 25, 1991, April 26, 1991, May 17, 1991, May 18, 1991, May 29, 1991, and May 30, 1991 addressed to the members of the Federal Reserve Board, the Attorney General of the United States, the United States Treasury Department and various banking institutions named as defendants herein, the plaintiffs have demanded settlement, release and distribution of the assets deposited in their accounts. There has been no response to the plaintiff's demands.

6. Plaintiffs allege that the refusal of the Defendants to release and distribute their property constitutes an interference with and a violation of contractual relationships.

7. Plaintiffs allege that their depository relationship with the various banking institutions is that of creditor and debtor and that the refusal to release and distribute the assets deposited in their accounts constitutes willful nonpayment of indebtedness. Plaintiffs further allege that the United States Treasury Department and the Federal Reserve Board have aided and encouraged this default.

8. Plaintiffs allege that banking institutions holding assets for their account and benefit are acting as trustees for the benefit of the plaintiffs, and in failing to acknowledge their rightful claims and in refusing to release and disburse assets held for them, the banking institutions have knowingly and willfully violated their fiduciary obligations. Plaintiffs further allege that the United States Treasury Department and the Federal Reserve Board have aided and encouraged this fiduciary breach of performance.

9. Plaintiffs allege that it is the clear purpose and policy of the national banking laws to protect the rights and interests of depositors and account holders. Plaintiffs further allege that the unlawful retention of their assets constitutes an improper hold on their depository account and is contrary to the spirit and intent of Federal Reserve Board Regulation CC which was promulgated on September 1, 1988 (12 CFR section 229 et. seq.).

10. Plaintiffs further allege that the refusal of defendant banking institutions, the United States Treasury Department, and the Federal Reserve Board to release, to settle and distribute the assets in the plaintiffs accounts indicate an intent to wrongfully deprive plaintiffs of assets to which they are entitled, and to wrongfully convert such funds to their own use.

WHEREFORE, Plaintiffs request this Honorable Court to:

(a) Grant a hearing on this matter.

(b) Inasmuch as irreparable injury has been suffered by the plaintiffs as a result of the deprivation of their property, they respectfully request the Court to issue a mandatory injunction against each of the defendants requiring them to settle the accounts and to release and distribute all assets shown to be the property of the plaintiffs.

(c) Award judgment to each of the plaintiffs in the amounts demonstrated by evidence of record to represent the value of their assets held by the defendants, together with interest, costs and attorney's fees.

(d) Grant such other and further relief as the Court may deem appropriate.

(Signature _____)
PAUL H. CHAPPELL
Attorney for Plaintiffs

109 North Adams Street
Rockville, Md. 20902
Tel: (301) 762-8865
Tel: (703) 590-0836

(Signature _____)
STEVEN CAMPEN [413528]
Attorney for Plaintiffs
Suite 1400
51 Monroe Street
Rockville, Md. 20902
Tel: (301) 294-6100
June 28, 1991

SO WHO MESSED IT UP?

Well, the point is now—WHERE IS IT NOW?

I do have a document showing that on or about May 18, 1992 a fax was sent to a contact from a representative who had received a telephone call with an update from one Dr. James Gilmore in London:

SBC:

May 16, Saturday p.m.

Telephone call from Dr. James Gilmore from London, England to M.P.

"Worked again Saturday. The group adjourned Sat. evening. All participants returned to their respective countries to get their superior's approval of the decisions reached at the London audit meeting. They will reconvene on Tues, May 26th to make the final decisions on funding the program.

"Dr. Gilmore feels very positive about the audit process and the final meeting on May 26.

"(Eight countries, many organizations and banks are involved. The program is dispersing more than five TRILLION dollars and will probably result in an increased return of 25-50% beyond the original return to all program participants. The word is PATIENCE!")"

At that time there was a notation "\$57 TRILLION DOLLARS" as to amount in point. Now, readers, that is a LOT of loot. Obviously it is far MORE than all the combined legal tender of all nations combined! But what you have are gross violations of the very laws written to allow such travesty of justice regarding laws.

You can continue to allow the manipulations and strangulation or you can get that amount of funding, albeit it *unConstitutional* as to coinage regulations—it is legal tender. NOW! It will not be for very much longer. You can work with the persons who originated these transactions and they will reward you greatly in service—or you can do nothing—and watch it slip away while you "wonder what hap-

SIGHT DRAFTS #
GVENTO C.A.M.

Two Sight Drafts Issued
For JT Each
109-H-130W
Drawn on Deutsche Bank
Issued 1st Sept 1988
Open-Ended
Assigned To
Assignment Remained But Could

Compagnia Assunsions Mandati
C.A.M.
Prof. ETIM-ETIM
Via Cicerone 60-00193 ROME

Heidelberg Trust
Issues Sight Drafts
to Confirm Existence of
Funds MAX ERBE

Manhattan
International
Bank
Dr. Wahbib Attar
Receives Affidavit
From Alain Marti
Banque Romande
Phone Conversation
with Banque
Romande Ofc. and
M.I.B. Can not
Confirm Collateral
from M.I.B. Dr.
Attar Confirms
Collateral will be
confirmed by
Barclays (London)

Not Provide Collateral Key Test

FORWARDS
DOCUMENTS TO
PROF. ETIM-ETIM

SENT A MARTI
DOCUMENTS

01087-H-129W
Drawn on Deutsche Bank
Issued 1st Sept 1988
Open-Ended
Assigned To
Assignment Remained BUT
Could Not Provide KTT of
Collateral

Develope Ireland Corp.
Thomas J. Cawley
Jonathan Brooks Solister

Robert Tomacari
Requested By T. Cawley
and J. Brooks to
Arrange Collateral

Mary Gosse Gardet
Marijan Milotec
Arrange Meeting at
Mayflower Hotel
New York
MARIJAN MILOTEC
Introduces James
Cadwell President
Knights Enterprises

Salah El-Shibib
Contracts with the Following
Parties to Arrange Collateral
1) Howard Nease and Assoc.
2) Internationa Alternative
Financing Ltd.
Jack Laning Pres
Hasem Aboulgar
Non-Performance

Western Canadian Rim
Investments
Josef Slyomovics Pres.
First National Bank of
Chicago
Account: Sam Jackson
Merril Lynch Texas
Non-Performance

Screens Sight Draft
Nos Thur State Bank
of India in Los
Angles. Confirms
Sight Drafts Are
Valid and
Assignments
to Joseph Koval Simon
and Marc De Mann

AT THIS TIME
WE
BECAME
AWARE OF
ASSIGNMENT
ON SIGHT
DRAFTS

* RECEIVED FAX FROM PROF. ETIM
TO JONATHAN BROOKS
CONFIRMING KTT TO
START TRANSACTION FOR
3 COLLATERAL WAS
CONFIRMED TO ANKER
BANK GENEVA SWITZ
ISSUED 10:11 88

Continental Bank and Trust
Bank Ofc Barry Thomson
Keytest to First Interstate
Bank of Nevada (Las Vegas)
Confirmed KTT: to Anker
Bank (Geneva Switzerland for
Alian Marti) (Under
Transaction Codes Issued By
T. Cawley/R. Tomacari to
Western Canadian Rim
Investments

Synescrow Trust
Evelynn Cecil
Arranges-KTT with
Crestar Bank.
Problem with Crestar
Bank Moved
Transactions to
Royal Bank of Canada
on Behalf of
Synescrow Trust
confirms to
Kredit Anstalt
Vienna, Austria
No Further
Communication
Provided

JAMES CROWLEY
NICO LIBIANO

Nico Libiano
President Martwell
arranges with
Manufactures and
TRADERS TRUST.
BUFFALO, NEW YORK.
CONFIRMS TO ALLIED
IRISH BANK DUBLIN
SIGHT DRAFT NUMBERS
GIVEN BY JAMES
CROWLEY

pened!" It's up to you.

We will have Mr. Dixon and the CLC involved to his eyes tomorrow for this day is gone. We will fax him the information, please, so he can come ready to contact these people listed so we can help with some publicity and major legal backing through the Constitutional Law Center. In combining our actions into one intended goal we can bring it about, readers—but it will require your efforts.

Since you will not know exactly what to write (but don't wait—if you do) we will ask Mr. Dixon to draw up a letter as a sample guide for you to add to with your own comments and personalization. This is NOT some "demonstration" or "gathering". This must be individual participation and it must be done immediately—the economic curtain is all but dropped—this is basically a LAST CALL TO ARMS IF YOU WISH TO HOLD YOUR NATION. I suggest you GO FOR IT!

We will ask that the letter be read on the phone line—give until Wednesday or Thursday. We will also make a copy available on APFN. We will then run the "sample" and Mr. Dixon's comments in the following CONTACT.

You are given a "chance", chelas—please don't waste it!

I salute you who would reclaim your nation and demand justice under the LAW. After all—it IS the adversary's own laws he has broken! AHO!

ATOMIC SUICIDE?

BY

DR. WALTER AND LAO RUSSELL

Illustrations by

Dr. Walter Russell

Introduction by

Lao Russell



UNIVERSITY OF SCIENCE AND PHILOSOPHY

FORMERLY THE WALTER RUSSELL FOUNDATION

SWANNANOVA, WAYNESBORO, VIRGINIA

ORDERING INFORMATION

The University of Science and Philosophy

P. O. Box 520

Waynesboro, VA 22980

Book Orders Only: (800) 882-5683

Other: (703) 942-5161

Atomic Suicide: \$20.00

Postage: \$3 first book

\$2 each additional book

*The bravest man is the one
who weighs up all the risks
and when they have be-
come greater than the ob-
ject is worth, has the cour-
age to turn back and to
face the other risk of being
called a coward.*

--Kurt Hahn

A maze

*Is a name they call a path
With no easy end.*

*Let it amaze your eye
But not stall your spirit.
Be yours the recourse*

Of a power

*Which when it created
a universe*

*May have left a way
out.*

--Witter Bynnar

Dont Forget The *Incredible* Eustace Mullins

THE CURSE OF CANAAN A Demonology of History

BY EUSTACE MULLINS

(COC) \$15.00 242 pages

"After forty years of patient study of the crises which face humanity, I arrived at a very simple conclusion--*all conspiracies are Satanic!*"

The "Will of Canaan" which has been the guiding rule of The Conspiracy for three thousand years is explained in explicit detail. Some topics covered are: The War Against Shem--The Transgression of Cain--Secular Humanism--American Revolution--The World Wars--French Revolution.

See last page for ordering information or you can order from:

Ezra Pound Institute of Civilization
P. O. Box 1105
Staunton, VA 24401

(shipping via Ezra Pound Institute is 10% of order--Bookrate shipping only)

MURDER BY INJECTION The Story of the Medical Conspiracy Against America

BY EUSTACE MULLINS

(MBI) \$15.00 361 pages

Eustace Mullins unveils the Conspiracy to deny you low cost alternative health care and how Federal agents commit acts of Criminal Syndicalism to protect the profits of the "Drug Trust". The World's 18 largest Drug Firms are listed. Some of the topics covered are: Profits of Cancer, AIDS, Contamination of the Food Supply, Death and Vaccination, The Rockefeller Syndicate.

See last page for ordering information or you can order from:

Ezra Pound Institute of Civilization
P. O. Box 1105
Staunton, VA 24401

(shipping via Ezra Pound Institute is 10% of order--Bookrate shipping only)

RAPE OF JUSTICE America's Tribunals Exposed

BY EUSTACE MULLINS

(ROJ) \$18.00 535 pages

This book reveals the Secret Code which judges and lawyers use to deny you your unalienable and civil rights protected by the *Constitution*. Some of the topics covered are: Legal Anarchy--The Origin of Law--A Plague of Lawyers--Judge Not--The Supreme Court--The Department of Justice--The Court as Arena--Freedom of Speech, Anyone?--Taxation Without Hope--The Taxing Power--Mullins on Equity--Our Legal Future.

See last page for ordering information or you can order from:

Ezra Pound Institute of Civilization
P. O. Box 1105
Staunton, VA 24401

(shipping via Ezra Pound Institute is 10% of order--Bookrate shipping only)

THE SECRETS OF THE FEDERAL RESERVE

BY EUSTACE MULLINS

(SFR) \$15.00 201 pages

After years of research, Eustace Mullins discovered that the men whom he exposed and named in 1952 as the shadowy figures behind the Federal Reserve System were themselves shadows, the American fronts for the unknown figures who became known as the "London Connection." The original stockholders of the Federal Reserve Banks have been located and their parent companies traced to the London Connection. His research is substantiated by citations and documentation from many sources.

See last page for ordering information or you can order from:

Ezra Pound Institute of Civilization
P. O. Box 1105
Staunton, VA 24401

(shipping via Ezra Pound Institute is 10% of order--Bookrate shipping only)

THE WORLD ORDER Our Secret Rulers

BY EUSTACE MULLINS

(TWO) \$15.00 297 pages

Eustace Mullins shares his discovery of the hidden manipulators of the World Order who have maintained their power by a very simple technique--a disguise which enables them to carry on their Satanic work without being identified and prosecuted. The topics covered are: The "New" World Order--The Rothschilds--Soviet Russia--Franklin Delano Roosevelt--The Business of America--The CIA--The Bechtel Complex--The Foundations--The Rule of the Order.

See last page for ordering information or you can order from:

Ezra Pound Institute of Civilization
P. O. Box 1105
Staunton, VA 24401

(shipping via Ezra Pound Institute is 10% of order--Bookrate shipping only)

Hydrogen Peroxide Use For Purification Of "Stuff"

Editor's note: We are re-running this important information on the purification uses of Hydrogen Peroxide not only because of its bearing on the New Gaia Products items (on the next-to-last pages) during these warmer summer months, but also because of the Elite's water contamination and other "plague" introduction plans.

4/27/93 #1 CERES 'ATONN

NECESSARY INSTRUCTIONS: GAIANDRIANA AND OTHER "PRODUCTS"

As we sit to pen this information I am at a loss as to how to keep you from thinking me idiot-material. However, you who already have past information, say, regarding Hydrogen Peroxide and its antiseptic-antibiotic properties, please be patient while we offer information to those who have not received same. Further, Summer is upon you and such as Gaiandriana and the Mo-Gu starters and/or tea need updated care instructions. [See next-to-last pages for the New Gaia Products being referred to here.]

We have gotten back from ONE who said he had the "stuff" tested and found a few bacteria, a virus or two and some E. Coli in the test-run. If it were the Gaiandriana I question that result very, very much. **It is important for you to know that in the culture medium utilized there is a combination of items which CREATE AND PRODUCE HYDROGEN PEROXIDE in the Gaiandriana transformation.** This will purify the liquid. This does not mean that you cannot contaminate the bottle in some manner. However, since intake decreases, usually, let us consider the "setting" bottle, etc. Of course it is recommended that you store the larger quantity in refrigeration facilities.

HOWEVER, if you have no refrigeration facilities, etc. Place the equivalent of 10 drops of food-grade (35%) hydrogen peroxide (H₂O₂) in a small quantity (approximately an ounce) of water (to first dilute the H₂O₂) and then add this diluted H₂O₂ to the 32-ounce

Gaiandriana or Aquagaia bottle. Remember to scale down the number of H₂O₂ drops utilized for the smaller 16-ounce and 8-ounce product bottles. The Gaiandriana or Aquagaia will continue to thrive and the unwanted bacteria and/or any virus will be destroyed and then actually removed by ingestion by the Gaiandriana or Aquagaia activity.

The "tea" (Mo-Gu) is a very different matter. You are making a very sweet growing medium for the membrane and in addition you are growing it in a warm condition (necessary) and further you are setting it for a couple of weeks or so, give or take a bit. What do I suggest? Well, I suggest that probably you won't want to ship much "tea" during the hot months because of lack of refrigeration in route. But, you CAN purify the water used in making the tea with the general rule-of-thumb water-purification formula of 7-10 drops of 35% food-grade H₂O₂ per gallon of water—which will additionally help enhance the membrane growth.

Then, later on, as you process or "harvest" the finished Mo-Gu tea product, and store it in the refrigerator, add another 7 to 10 drops (say, for a gallon storage container of Mo-Gu, with scaled down number of drops for smaller storage containers) of the 35% food-grade H₂O₂. Again, first dilute the H₂O₂ in some water before adding to the Mo-Gu. You will not taste it and neither will it hamper the value.

I always suggest, in adding any 35% food-grade H₂O₂ to anything, that it be **DILUTED FIRST**. Just as you must NEVER drop concentrated anything into the mouth (for it would damage living cellular structures), neither do you dump it full-strength into living culture medium. Dilute it in a bit (say, an ounce) of water first and **STIR** rapidly whatever it is you are dumping the diluted H₂O₂ into for purification purposes. Naturally, if just purifying a gallon of water, there is no need for active stirring, though a little closed-container agitation (a few shakes) won't hurt.

GETTING "SLIMED"

Another question: What about that

slimy goo in the bottom of the bottle of Gaiandriana or Aquagaia if left out of refrigeration? GOOD GOO! I suggest you now go get some FOOD-PROCESSED ALOE VERA LIQUID. Take a half cup or so of it (some of it is even orange or lemon-lime flavored, etc.) and dump in the "goo" and last portion of a Gaiandriana or Aquagaia bottle. Or, strain the "goo" out of its original bottle and place it into the new aloe vera "home". Leave set for a couple of days and you will have a concentrated batch of Gaiandriana or Aquagaia product which will be an addition to the original bottle.

This is NOT a replacement for the original batch you get for it will not contain all you need. However, in ones who intake products which tend to kill off a portion of the Gaiandriana in the body (like caffeine in coffee)—this will enhance the potency—even if you just drink a little. Remember, Aloe Vera itself has a tendency to make some people feel "queazy" so DO NOT OVERDO how much of this you drink!! However, a full-blown AIDS victim could take ten times a "normal" amount and only improve—for perhaps "feeling good" is a very relative state of being.

Some people are going to run fevers and have "crisis" symptoms as healing takes place. If this goes on for very long, look to other health problems for the cause. First, treat the "liquid batch" with hydrogen peroxide as above described. THEN start on a regimen of hydrogen peroxide according to the instructions given again herein [chart on following page at bottom].

I happen to know that you do not need to work up to any 25 drops as the instructions [following] claim UNLESS you are suffering from flu, infection, or other maladies. If you are "well" and "anything" makes you feel bad—either stop it or, certainly, decrease the amount. USE YOUR REASONING MIND!! Like anything of this nature—TOO MUCH WILL MAKE YOU SICK OR BE DETRIMENTAL—EXCEPT WITH GAIANDRIANA—AND THEN EVEN THOUGH YOU MIGHT NOT FEEL GOOD (BECAUSE OF THE OVERDOSE OF ALOE FROM THE CUL-

TURE MEDIUM), YOU WON'T HURT YOURSELF.

HYDROGEN PEROXIDE — H2O2
(35% Food Grade)

Purchase a small eye dropper bottle at the drug store. Fill your small dropper bottle from the large bottle as needed. The large bottle may be stored in the refrigerator or in the freezer inside another plastic container. The small eye dropper bottle should also be kept in the refrigerator. **Always use caution when handling 35% hydrogen peroxide!**

DO NOT use with carrot juice, carbonated drinks or alcohol. For best results, take on an empty stomach 1 hour before a meal or 3 hours after meals.

Formula: Mix the number of drops of 35% hydrogen peroxide into at least 6 oz. of distilled water, juice or milk and stir vigorously, then drink the mixture. Some people eat 1/4 to 1/2 of a banana immediately after drinking the solution. You may prefer something else to eat.

If your stomach gets upset at any level, stay at that level or go back one level. Then proceed to increase your daily dosage again.

When free of complaints you may taper off by taking:
25 drops once every other day for 1 week,
25 drops once every 3rd day for 2 weeks,
25 drops once every 4th day for 3 weeks.

A good maintenance could be 5-15 drops per week, or whatever makes you feel good.

If you get the 35% hydrogen peroxide on your skin rinse it under running water for several minutes.

Soak feet: 1-1/2 oz. 35% to 1 gal. of water.

Bath: 16 oz. 35% to a tub of water to detoxify.

Colonic: 1/2 pt. of 3% per 5 gal. of water.

Douche: 6 tablespoons of 3% per qt. of water.

Candidiasis: 1 drop of 35% 3 times a day; then increase schedule.

For the more serious complaints, stay at 25 drops 3 times per day for 1 to 3 weeks. Then graduate down to 25 drops two times per day until your problem is taken care of. This may be from 1 to 6 months.

If you have a weak stomach you may experience nausea similar to that in pregnancy. Also as dead bacteria or various forms of poisons are released you will experience a cleansing effect as they are released through the elimination organs

of the body: skin, lungs, kidneys and bowels.

Some reactions to the cleansing effect could include skin eruptions, nausea, headaches, sleepiness, unusual fatigue, diarrhea, head or chest cold, ear infections, boils or any other ways the body uses to loosen toxins. This is a natural cleansing of the body and should be of a short duration as you continue to maintain your program.

Formula to make a 3% solution of hydrogen peroxide. Put 1 oz. of 35% hydrogen peroxide in a pint jar. Add 11 oz. of distilled water. This will give you 12 oz. of 3% H₂O₂. Use also for brushing teeth and applying to skin sores.

Do not use 35% H₂O₂ if you have had a transplant.

TO THOSE OF YOU WAITING
FOR NEW STRENGTH OF PRODUCT

Because I have mentioned that work is being done on strengthening the Gaiandriana, some of you are backing off and waiting. Please don't do that for research is being done and it will be a while. In addition, one of the items in the medium is being removed in order to enhance the strength. This will mean that you can get the same basic result by adding some food-processed aloe vera to the initial product which will allow a higher level of Gaiandriana presence. Gaiandriana will only grow to its level of fuel (food) available—so just treat the product accordingly.

I am, further, requesting that all further product be receiving hydrogen peroxide for purification purposes. Any

that YOU ADD, however, will only enhance—not damage.

OTHER PRODUCTS

We have tried to make available other products to use in conjunction with the Gaiandriana. **USE YOUR REASON HERE ALSO!!** If something makes you feel bad—don't use it!, cut back on amount or forget it altogether. These are all natural substances so remember, if you are eating anything that makes you feel bad—you quit eating it, right? Just continue the Gaiandriana—I promise you—it is not making you ill. If you are reacting, then it may be due to the "base" or "combining" substance in tableting, etc.

CHLORELLA

We get complaints about chlorella causing indigestion, etc. Chew the tablets or dissolve in a bit of liquid before intake.

Now again, use reason. Are you still eating in addition to the chlorella? Well, perhaps you will wish to reduce the intake. It is better for you than food but you **DONT NEED EVERYTHING**. We are efforting to show you what you could take with **NO** food in survival situation **AND STILL BE ABUNDANTLY HEALTHY**. Adjust your intake accordingly. If you are caught in an emergency and need survival sustenance—now you know what to take for health needs.

You can subsist on chlorella and water alone. Add Mo-Gu tea, a bit of spelt bread and some lentils (preferably red)

| DAY # | NUMBER OF DROPS | TIMES PER DAY | |
|-------|-----------------|---------------|---|
| 1 - | 3 - | 3 - | |
| 2 - | 4 - | 3 - | |
| 3 - | 5 - | 3 - | |
| 4 - | 6 - | 3 - | |
| 5 - | 7 - | 3 - | Adding 7 drops 35% H2O2 to 1 gallon drinking water purifies it. Shake well. |
| 6 - | 8 - | 3 - | |
| 7 - | 9 - | 3 - | |
| 8 - | 10 - | 3 - | |
| 9 - | 12 - | 3 - | |
| 10 - | 14 - | 3 - | |
| 11 - | 16 - | 3 - | |
| 12 - | 18 - | 3 - | |
| 13 - | 20 - | 3 - | |
| 14 - | 22 - | 3 - | |
| 15 - | 24 - | 3 - | |
| 16-22 | 25 - | 3 - | |

and you can live healthily ever after—in other words, it would not be malnutrition that would “getcha”. **AND ALWAYS KEEP FOOD-GRADE HYDROGEN PEROXIDE AVAILABLE TO PURIFY EVERYTHING. REMEMBER, 7 DROPS OF 35% FOOD GRADE HYDROGEN PEROXIDE TO A GALLON OF WATER WILL PURIFY IT AND THE WATER WILL PICK UP A MUCH IMPROVED “FLAVOR” OF FRESHNESS—UNDER MOST CIRCUMSTANCES NOT EVEN NOTED AT ALL.** THIS is why one of the first items confiscated from health food stores, labs, and so on—**IS HYDROGEN PEROXIDE IN FOOD GRADE.** I remind you readers of long standing: the best treatment for arthritis and other seemingly “incurable” diseases is hydrogen peroxide therapy in accompanying regimen of Gaiandriana which moves in and restores the cellular restructuring of self.

CRYSTAL LIFE

That is an exceptional product but has become almost out of sight expensive. However, the best results with Gaiandriana are being reported with continued, even if remarkably decreased amounts, of Crystal Life continued right along in conjunction with the Gaiandriana—mixed or otherwise. About 8 to 10 drops mixed or separate under the tongue three times a day is excellent. In illness, however, increase within reason. If I did not already state it prior to this—add 7-10 drops of hydrogen peroxide per quart to the Crystal Life also—especially if non-refrigerated, after opening. This will decontaminate any possible “unwanted visitors” and not damage the product.

WATER

I cannot urge you often enough to **TREAT** your faucet water. Even if you have a reverse-osmosis unit—treat that water with proper amounts of hydrogen peroxide for **YOU DO NOT KNOW WHAT IS IN THAT WATER. IT WON'T HELP CONTAMINATION BY TOXINS BUT IT WILL TAKE CARE OF THE VIRAL OR BACTERIAL CONTAMINATES. IT IS CHEAP AND NON-TOXIC IN PURIFICATION AMOUNTS.** The best mouthwash and gum enhancer is a mouthwash of several drops of hydrogen peroxide in a fourth cup of water (or so) and cleanse mouth after brushing (or just do it several times a day as convenient). If the solution is “light” just swallow the wash—it can only help you unless you have an active mouth infection. Moreover I suggest keeping some hydrogen peroxide near and handy to drop a few drops of undiluted peroxide on your

toothbrush a couple of times a week—or daily—whatever. You will have a sterilized brush and stop spreading germs and recontamination.

SPILLING

If you spill full strength (35%) peroxide on your skin—it will burn you. Rinse immediately under water and it will be fine. It will bleach so rinse anything that gets spattered—in water. It is simply one of those substances which needs to be handled properly. Peroxide offers so many “cleaning” uses that I won't even effort to list them—but you will find it about the most useful item around your kitchen, bath, etc. You can find information at health food stores and vitamin supply outlets.

Our people may also be able to direct you or help you with product or information; I do not attend those things unless brought to my attention. We offer these things as a service rather than a

major business so we are perhaps remiss in full-range material. We can do better when the full load eases a bit. Thank you for your patience and loving support of the ones who have taken this load on in addition to their other tasks—ever without complaint and ever wishing to help and please. At present they are trying to build refrigeration facilities to bring you exceptional product as the months heat up and yet do so with very, very limited resources—so we do thank you for your patience. With George Green's attack on the Institute a lot of things have had to wait or be actually closed down until the audits are over and the reclamation can begin. As you might realize, the impact has been great on all entities in these projects. It is fine—rewards will be in like measure to that which is given forth.

I ask that this message be both run in the paper and sent in addition to all packings in mailings of product.

Thank you.



The Political Transformation of Boris Yeltsin



COMMUNIST FUNCTIONARY



DEMOCRATIC LEADER



FRIEND OF BILL

New Gaia Products

GAIANDRIANA

Gaiandriana is a non-alcoholic health tonic which provides basic "foods" to help cells, weakened by the stresses of modern life, to return to a state of health.

The better our cells function, the greater is the stamina returned to our internal defense systems, and the better we can counter the constant onslaught of biological and viral invaders. The end result is a feeling of well-being by, of course, being well!

The Gaiandriana (commonly referred to as "chondriana" in the Biological literature) are capable of intelligent, organized attack against cellular invaders like viruses. Think of it as a "pac-man" operation of sorts. However, beyond that, the Gaiandriana are capable of stimulating cellular structural repairs due to damage caused by, for instance, free radicals and cumulative levels of so-called "background" radiation in our modern environment. Healthy DNA and RNA within the nuclei of our cells then lead to properly formed and concentrated enzymes, upon which healthy cellular function depends.

Gaiandriana liquid is made entirely from wholesome natural ingredients.

AQUAGAIA

Complementary to the Gaiandriana product, Aquagaia is also a non-alcoholic health tonic which provides basic "foods" to help cells, weakened by the stresses of modern life, to return to a state of healthy function.

Aquagaia contains *mitochondria*. These are the major biochemical energy "processors" within cellular metabolism. First, enzymes begin the breakdown process of organic nutrients (like fats, carbohydrates and proteins) to intermediate substances such as amino and pyruvic acids. Then, in the next "bucket brigade" step, these various acid molecules are processed within the mitochondria to release chemical energy recognized as adenosine triphosphate (ATP).

About 95% of the energy needed to "run the machinery" that keeps each cell going and healthy is produced in the mitochondria. Unfortunately, the mitochondria are particularly damaged by free radicals and cumulative levels of so-called "background" radiation in our modern environment. These compromised mitochondria, like half-dead batteries, then lead to impaired cellular functioning and health. Thus is the importance of Aquagaia, with its assimilable

supply of healthy mitochondria — like "fresh batteries" for the body's cells.

The better our cells function, the greater is the stamina returned to our internal defense systems, and the better we can counter the constant onslaught of biological and viral invaders. The end result is a feeling of well-being by, of course, being well.

2/11/93 #2 HATONN

GAIANDRIANA AND AQUAGAIA:

To help in understanding the workings of these organic "pac-men" you must realize that there is a protein covering "cap" on viruses. The protein cap is centered on a charged zinc atom and is the part of the virus that recognizes and binds to DNA—in turn allowing the virus to reproduce.

Aquagaia, in conjunction with the Gaiandriana, knock out the zinc atom (a simple "charge" change), which renders the protein ineffective. This is a breakdown of "parts" of the Gaiandriana male/female DNA structure which release many working variants but frees the Gaiandriettes or "killers" to take out that zinc atom and pass right into the affected cell. Without the "cap", the virus cannot reproduce and infect more cells—further, the damaged virus feeds the Gaiandriana unified cells and the circulating mitochondria.

Healthy cells are not affected because they lack the zinc-centered protein cap on the virus.

These "Gaia" compounds have an effect on cancer cells because they stop an enzyme on the cancer cells from producing a "messenger" molecule that blocks a second enzyme from attacking the cancer cell's DNA. The compounds (Gaia) have been seen to actually take-out leukemia, breast, brain and colon cancer cells. We have no claim to anything other than stating that people utilizing these simple and natural substances do show improved well-being and do report feeling generally and, often remarkably, improved as to state of health, thought processes and stamina.

The obvious conclusion is that there might well be good reports of better health and faster recovery following infection by other viruses than those mentioned above. All viruses known react in generally the same manner.

It is known that many diseases are due to retroviral DNA and these are the most affected viruses by the Gaia-chondrianas (living crystal forms). We, again, make no medical claims—we

are simply reporting in an effort to explain WHAT takes place within the cellular structures of living organisms. If you really want to witness remarkable growth in plants and good stamina and health in pets and other animals—try a little of these additives as you would vitamins or fertilizers. Use in a mildly vitamin C based solution on same. At transplant time for garden plants and houseplants—soak their little root systems in this natural and mild solution. Just add a tablespoon of Gaiandriana, a few drops of liquid vitamin C or C-crystals to a quart of water and let set for 48 hours—then it is ready for use. It will not negatively interact with anything other than perhaps harbored viruses and disease spores and organisms.

NOTE

If any product you receive has an unpleasant odor—it is from the finishing culture process. Leave the bottle open to air and it will quickly dissipate. Then, depending on taste and preference—refrigerate after opening and reclosing.

IMPORTANT: Do not mix the two, Gaiandriana and Aquagaia, together for storage as the Aquagaia (mitochondria) is aggressive and begins to "eat" the Gaiandriana for fuel. They go about their appointed tasks once ingested, but in bottle prisons they are not particularly compatible once the available fuel supply is exhausted. Juices are excellent to take with the Aquagaia because the mitochondria must have the fuel derived from same, the most effective juice being from the tropical "Guava" fruit. Any juice is fine, however, and is most pleasant to intake. Diabetics should utilize whatever juices are available on their food plan to keep within the safe guidelines for calories and other requirements.

The most innocuous and easy intake available is simply a few drops under the tongue, both products taken at the same time or at different times of the day. Once the "initial" program is begun and maintenance is followed, certainly the drops under the tongue are the least annoying to any daily regimen.

A-C-E ANTI-OXIDANT FORMULA

There is growing evidence that essentially everyone in our society is exposed to free radicals, now more than ever. While free radicals are normal products of our cells and have certain beneficial roles in the body, increased levels of free radicals in our body tissues can be detrimental to our health.

Free radicals are highly unstable substances produced in the body through, among other routes, the metabolism of oxygen. Free radicals multiply through a series of chain reactions and can attack the polyunsaturated fatty acids of cell membranes. Unless excess free radicals are neutralized, they can cause considerable damage to the structure and function of cell membranes, and thus the cells themselves. The

products from free radical reactions are implicated in the progressive accumulation of deleterious cellular changes over time, which may eventually result in recognizable disease. Free radical damage is implicated in the initiation and promotion of many cancers, as well as hardening of the arteries.

One area of Aging Research suggests that free radicals damage body cells and cause the pathological changes associated with aging. Besides being byproducts of the metabolism of oxygen, such as during strenuous exercise, we also generate significant levels of free radicals from the environment, such as from so-called "background" levels of ionizing radiation.

Cooperative defense systems that can protect the body from free radical damage include certain enzymes and the antioxidant vitamins A, C, and E and beta-carotene, which protect cell membranes from oxidative damage. Vitamin E, one of the fat-soluble vitamins, is present in the blood as d-alpha-tocopherol and is well accepted as the major antioxidant in lipid body tissues. Vitamin E is considered the first line of defense against cell-membrane damage due to peroxidation. Vitamin E scavenges free radicals, terminating chain reactions and confining damage to limited areas of the membrane. Selenium contained in the enzyme glytathione peroxidase is the second line of defense that destroys peroxides before they can damage cell membranes. Beta-carotene, a precursor of Vitamin A, also traps free radicals. Vitamin C is water soluble and serves to neutralize free radicals in aqueous systems.

The antioxidants show promise as cancer-prevention agents, alone and in combination.

GINKGO BILOBA

(Ginkgo Biloba extract 24%)

The Ginkgo Biloba, or Maidenhair tree, is one of the oldest living species on this planet. Ginkgo has flourished almost unchanged for 150 million years, and its ancestors can be traced back 250 million years. It is because of this antiquity that the Ginkgo Biloba tree is called "the living fossil". Individual trees are believed capable of living 2000 to 4000 years. During the last ice age, Ginkgos nearly became extinct. These trees survived only in China and other parts of Asia, where they stayed until approximately 1,000 years ago. At that time, Ginkgo trees were also planted around monasteries in Japan, where they still live today.

The name *Ginkgo* may come from the Chinese *Sankyo* or *Yinkuo* (Yin Guo), meaning "hill apricot" or "silver fruit". The word *biloba* means "two lobes" and describes the young leaves. Although modern medical research focuses mainly on the leaves of Ginkgo, the Ginkgo fruits and nuts have been used in China since time immemorial as a delicacy and tonic food. Ancient Chinese texts record Ginkgo's use as a medicinal agent as far back as five thousand years ago.

The Ginkgo Biloba extract is a complex compound. The green leaves of the tree are

usually harvested from trees grown on plantations in South Korea, Japan and France.

Ginkgo is reported to have a natural affinity for the nervous system. It also seems to stimulate the vascular and endocrine systems that, in turn, strongly affect the function of the nervous system, possibly increasing the capacity for normal physical activity, and the flow of blood to the brain. Some research indicates the possible effectiveness of Ginkgo in the treatment of *Alzheimer's* disease.

Due to its pharmacological properties, Ginkgo is now widely used throughout Europe for treating many forms of vascular disease. In a survey of packaging information of European products, Ginkgo has been recommended for such ailments as headaches, vertigo, inner-ear disturbances, diminished intellectual capacity and alertness as a result of insufficient circulation to the brain, anxiety, and depression, to name a few.

Ginkgo Biloba Extract (24%) is concentrated from the leaves of the Ginkgo Biloba tree. The highly specialized extraction process yields a 50:1 concentrate from the leaves (50 grams of leaf produce 1 gram of extract). The extract is then further standardized to contain 24% of the active Ginkgo Flavoglycosides.

MO-GU ELIXIR

The first recorded use of Mo-Gu Elixir was during the Chinese Tsin-Dynasty in 221 B.C. It was referred to as "The Remedy for Immortality" or "The Divine Tsche".

It has been well documented that there are certain people who live to be well past a hundred years of age. These people live in such areas as the mountainous Caucasus, Yakutia in Siberia, the Poltava District of the Ukraine, Tibet and Spain. There is an area in Russia called Kargasok where the people are a dairy- and vegetable-eating populace. Centenarians are common among these people. They attribute their longevity to the Yeast Enzyme Tea (Mo-Gu Elixir) which has been in their diet for hundreds of years. It is said that Mo-Gu and yak butter are staples among the dwellers of the high Himalayas.

Mo-Gu has been used throughout history in China, Japan, Russia, Korea, and India. It has been said to promote a feeling of well-being and overall physical restoration. It has been known by many names, some of which are: Fungus Japonicus, Fungojapon Kombucha, Pichia Fermentans, Cembuya Orientalis, Combuchu Tschambucco, Volga-Spring, Champignon de Longue Vie, Teekwass, Kwassan, and Kargasok.

The Mo-Gu fungus constructs in a membrane form and is a symbiosis of yeast cells and different bacteria. Among these bacteria are: Bacterium Xylinum, Bacterium Gluconicum, Acetobacter Ketogenum, and Pichia Fermentans.

The Mo-Gu fungus needs to live in a solution composed of common (black) tea and sugar. In the proper temperature environment they multiply constantly. They do not build spores as yeast normally does, but instead multiply by a process of branching.

CHLORELLA

Chlorella is a single-celled, fresh-water algae. Believed to be the first form of life with a true nucleus, chlorella dates back approximately 2.5 billion years, making it *pre-Cambrian*. Through the process of photosynthesis chlorella cells reproduce themselves by cell division at the rate of four new cells every 17-24 hours. It was not until the 1890s that chlorella was identified under the microscope. In naming it, the prefix *chlor* was selected to signify green, while the suffix *ella*, indicates small. Chlorella is the most researched algae in the world and remains the most popular with millions of consumers worldwide.

Chlorella is a nutritionally balanced whole food and contributes to the health and growth of human cells like no single vitamin or mineral possibly can.

Chlorella is extremely high in protein (60%) and contains more than 20 vitamins and minerals, 19 of the 22 essential and non-essential amino acids, enzymes and chlorella growth factor. It is one of the richest sources of RNA and DNA known and has twenty times as much chlorophyll as alfalfa, 10 times more than other edible algae including spirulina, and 10 times more than barley grass.

Chlorella is a natural vitality enhancer. The vitamins found in chlorella cells include: Vitamin C, provitamin A, B-carotene, chlorophyll a, chlorophyll b, thiamine (B1), riboflavin (B2), pyridoxine (B6), niacin (B3), pantothenic acid, folic acid, vitamin B-12, biotin, choline, vitamin K, PABA, lipoic acid, inositol and para-aminobenzoic acid. The minerals include: phosphorus, potassium, iodine, magnesium, sulphur, iron, calcium, manganese, copper, zinc and cobalt.

The amino acids include: lysine, histidine, arginine, aspartic acid, threonine, serine, glutamic acid, proline, glycine, alanine, cystine, valine, methionine, isoleucine, leucine, tyrosine, phenylalanine, ornithine, tryptophan.

The suggested daily consumption is 3 grams per day.

ECHINACEA GOLD PLUS with American Ginseng

In recent years few medicinal plants have garnered as much attention as Echinacea (*Echinacea Purpurea* and *Echinacea Angustifolia*). The genus name is derived from the Greek *echinos*, (hedgehog or sea urchin) referring to the prickly scales of the dried seed head. Echinacea was widely used medicinally among Native Americans, particularly in the Plains. It is a product which is now used widely throughout United States and Europe.

Echinacea is a non-specific stimulant to the immune system. Claims for Echinacea include: stimulation of leukocytes, mild antibiotic activity, anti-inflammatory activity, stimulation of the adrenal cortex, stimulation of the properdin/complement system, interferon-like activity, stimulation of general cellular immunity, and

antiviral activity. Internal preparations are said to assist in alleviating cold and flu symptoms, respiratory infections, and arthritis, to name a few.

Goldenseal (*Hydrastis Canadensis*) is generally placed in the buttercup family. The name Goldenseal was adopted in 1880, previously having been known as Yellow Root. Goldenseal was widely used among the Native American population, particularly among those in the East. The Cherokee used the roots as a wash for local inflammations, for general debility, dyspepsia and to improve appetite. The Iroquois used it for whooping cough, diarrhea, liver trouble, fever, sour stomach, flatulence, and pneumonia. Benjamin Smith Barton first referred to the use of Goldenseal for rattlesnake bites as early as 1793. Clinical recognition of the use of Goldenseal came in the early 1850s and has continued to this very day.

Goldenseal is among the most popular herbs in the American health food market. Uses are numerous, including but not limited to: antiseptic, hemostatic, diuretic, laxative, and tonic/anti-inflammatory for the mucous membranes, hemorrhoids, nasal congestion, mouth and gum sores and eye afflictions.

Ginseng can be literally translated from Chinese as "the essence of man" or "man-shaped precious root." Few medicinal plants in the world possess Ginseng's near-legendary status. Dating back thousands of years, its history of use in the Orient records therapeutic properties so wide ranging that it was first dismissed by Western doctors as a "panacea". When fatigued, Ginseng reportedly restores both physical and mental functions to peak efficiency and, with regular use, improves resistance to disease and stress. American Ginseng's genus name is *Panax Quinquefolius*.

Over 40,000 species of mushrooms exist, many of which are used as medicines. Of particular note are such remedies as penicillin- and ergot-based extracts used in migraine treatment, to name a few. Extensive research has been done with one mushroom in particular, namely, Reishi. This mushroom is now considered a tried and true immune system fortifier.

References to the use of Reishi in the treatment of a variety of complaints date back as far as 2700 B.C. in Chinese literature. It is referred to by a number of names, including the "ten thousand year mushroom". The rarity of this particular mushroom has increased its value. The Chinese emperor Shih Huang Ti (250-210 B.C.) mounted expeditions of hundreds, even thousands of men to find the Reishi. Recently techniques have been developed for the cultivation and harvesting of the Reishi Mycelium. Writings about Reishi place it in the category of "fu zheng" herbs and claim it is a medicine that improves the ability of the body to maintain balance by strengthening natural resistance and generally improving health.

New Gaia Products
P. O. Box 27710
Las Vegas, NV 89126

For credit card orders, call (805) 823-1644

We accept Discover, Visa or Master Card.
 Please make all checks and money orders payable to: **New Gaia Products**

| (NAME) _____ | | | | | |
|--|--|------------------|------------------|---|-------|
| (ADDRESS--PLEASE GIVE STREET ADDRESS FOR UPS DELIVERY.) _____ | | | | | |
| (CITY) _____ | | | | | |
| (STATE) _____ | | (ZIP CODE) _____ | | (TELEPHONE) _____ | |
| CREDIT CARD (Visa, Master Card or Discover) _____ EXP. _____ | | | | | |
| SIGNATURE _____ | | | | | |
| QUANTITY | ITEM | PRICE PER BOTTLE | 10-19 (LESS 10%) | 20 OR MORE (LESS 15%) | TOTAL |
| | GAIANDRIANA 8 oz. LIQUID (no discount) | \$21.00 | \$21.00 | \$21.00 | |
| | GAIANDRIANA 16 oz. LIQUID (no discount) | \$41.00 | \$41.00 | \$41.00 | |
| | GAIANDRIANA 32 oz. LIQUID (1qt.) (no discount) | \$81.00 | \$81.00 | \$81.00 | |
| | AQUAGAIA (Mitochondria) 8 oz. LIQUID (no discount) | \$21.00 | \$21.00 | \$21.00 | |
| | AQUAGAIA (Mitochondria) 16 oz. LIQUID (no discount) | \$41.00 | \$41.00 | \$41.00 | |
| | AQUAGAIA (Mitochondria) 32 oz. LIQUID (1 qt.) (no discount) | \$81.00 | \$81.00 | \$81.00 | |
| | MO-GU ELIXIR Culture Start (LIQUID) (no discount) | \$40.00 | \$40.00 | \$40.00 | |
| | A-C-E Anti-Oxidant Formula (180 TABLETS) | \$24.95 | \$22.46 | \$21.21 | |
| | GINKGO BILOBA (24% Extract) (180 TABLETS/40 mg. EA.) | \$24.95 | \$22.46 | \$21.21 | |
| | CHLORELLA (1/2 LB) (500 TABLETS - 500 mg. EA.) | \$32.00 | \$28.80 | \$27.20 | |
| | ECHINACEA GOLD PLUS (90 TABLETS) | \$24.50 | \$22.05 | \$20.83 | |
| SUB-TOTAL | | | | | |
| SHIPPING (ALL ORDERS) | | | | | |
| TOTAL | | | | | |
| **PLEASE USE THE SHIPPING RATE CHART BELOW WHEN CALCULATING SHIPPING FOR ALL New Gaia Products. | | | | | |
| SHIPPING RATES: | | | | NOTE: | |
| ORDER | UPS | UPS 2ND DAY AIR | | **For UPS 2nd day to Rural Alaska, please call for rates. | |
| | GROUND | STATES | ALASKA/HAWAII | **For Priority Mail to any location, please call for rates. | |
| \$ 0-100 | \$5.25 | \$11.00 | \$16.75 | **All Foreign orders, please, contact our office in writing for specific rates as rates vary greatly. | |
| \$ 101-200 | \$5.75 | \$13.00 | \$19.00 | | |
| \$ 201-300 | \$6.25 | \$16.50 | \$22.50 | | |
| \$ 301-400 | \$7.00 | \$19.00 | \$25.00 | | |
| \$ 401-500 | \$7.50 | \$21.25 | \$30.50 | | |
| \$ 501-600 | \$8.00 | \$24.50 | \$33.50 | | |
| DUE TO PRODUCT SUPPLY AND DEMAND, PLEASE ALLOW 4-6 WEEKS FOR DELIVERY. | | | | | |

PHOENIX JOURNALS LIST

THESE WORKS ARE A SERIES CALLED THE **PHOENIX JOURNALS** AND HAVE BEEN WRITTEN TO ASSIST MAN TO BECOME AWARE OF LONGSTANDING DECEPTIONS AND OTHER MATTERS CRITICAL TO HIS SURVIVAL AS A SPECIES. **JOURNALS** ARE \$7.95 EACH PLUS SHIPPING. ORDER 4 OR MORE AND DEDUCT 10%.

**** These marked JOURNALS are out of stock until further notice.**

1. SIPAPU ODYSSEY
- **2. AND THEY CALLED HIS NAME IMMANUEL, I AM SANANDA
- **3. SPACE-GATE, THE VEIL REMOVED
4. SPIRAL TO ECONOMIC DISASTER
5. FROM HERE TO ARMAGEDDON
6. SURVIVAL IS ONLY TEN FEET FROM HELL
- **7. THE RAINBOW MASTERS
9. SATAN'S DRUMMERS
10. PRIVACY IN A FISHBOWL
11. CRY OF THE PHOENIX
12. CRUCIFIXION OF THE PHOENIX
13. SKELETONS IN THE CLOSET
14. RRPP - RAPE, RAVAGE, PILLAGE AND PLUNDER OF THE PHOENIX
15. RAPE OF THE CONSTITUTION
16. YOU CAN SLAY THE DRAGON
17. THE NAKED PHOENIX
18. BLOOD AND ASHES
19. FIRESTORM IN BABYLON
20. THE MOSSAD CONNECTION
21. CREATION, THE SACRED UNIVERSE
23. BURNT OFFERINGS
24. SHROUDS OF THE SEVENTH SEAL
25. THE BITTER COMMUNION
26. COUNTERFEIT BLESSINGS THE ANTI-CHRIST BY ANY NAME: KHAZARS
- **27. PHOENIX OPERATOR-OWNER MANUAL
28. OPERATION SHANSTORM
29. END OF THE MASQUERADE
38. THE DARK CHARADE
39. THE TRILLION DOLLAR LIE THE HOLOCAUST VOL. I
- **40. THE TRILLION DOLLAR LIE THE HOLOCAUST VOL. II
41. THE DESTRUCTION OF A

- PLANET--ZIONISM IS RACISM
42. UNHOLY ALLIANCE
 43. TANGLED WEBS VOL. I
 44. TANGLED WEBS VOL. II
 45. TANGLED WEBS VOL. III
 46. TANGLED WEBS VOL. IV
 - **47. PRE-FLIGHT INSTRUCTIONS VOL. I
 48. TANGLED WEBS VOL. V
 49. TANGLED WEBS VOL. VI
 - **50. THE DIVINE PLAN VOL. I
 51. TANGLED WEBS VOL. VII
 - **52. TANGLED WEBS VOL. VIII
 - **53. TANGLED WEBS VOL. IX
 - **54. THE FUNNEL'S NECK
 - **55. MARCHING TO ZION
 - **56. SEX AND THE LOTTERY
 - **57. GOD, TOO, HAS A PLAN 2000, DIVINE PLAN VOL. II
 - **58. FROM THE FRYING PAN INTO THE PIT OF FIRE
 - **59. "REALITY" ALSO HAS A DRUM-BEAT!
 61. PUPPY-DOG TALES
 62. CHAPARRAL SERENDIPITY
 63. THE BEST OF TIMES
 64. TO ALL MY CHILDREN
 65. THE LAST GREAT PLAGUE
 66. ULTIMATE PSYCHOPOLITICS
 67. THE BEAST AT WORK

- EX 1. PHOENIX JOURNAL EXPRESS VOLUMES I & II (BOOK) \$11.95
- EX 2. PHOENIX JOURNAL EXPRESS VOLUMES III & IV (BOOK) \$11.95
- EX 3. PHOENIX JOURNAL EXPRESS VOLUMES V & VI (BOOK) \$11.95
- EX 4. PHOENIX JOURNAL **EXPRESS VOLUMES XIII & XIV (BOOK) \$15.95
- **EX 5. PHOENIX JOURNAL EXPRESS VOLUMES XV & XVI (BOOK) \$19.95

HELP SPREAD THE WORD

PURCHASE MULTIPLE COPIES OF THIS AND OTHER ISSUES OF **CONTACT: THE PHOENIX PROJECT** AND PASS THEM OUT TO YOUR FRIENDS

**CONTACT:
THE PHOENIX PROJECT**
TELEPHONE
HOTLINE
805-822-0202

This is a service for our dedicated readers. *Today's Watch* telephone hotline carries the latest news and comments from Commander Ceres 'Atonn's most recent writings. This is our way of keeping you informed about fast-breaking news and events.

The message machine will answer after 2 rings if there are any new messages for that day, and after 4 rings if not. Thus *daily* callers can hang up after 2 rings and save toll charges if no new message has been recorded. The message update(s), if any, occur by 6 PM Pacific Time.

FOR INFORMATION ABOUT JOURNALS, BOOKS, ETC., MENTIONED IN THIS NEWSPAPER, PLEASE CONTACT:

PHOENIX SOURCE DISTRIBUTORS, Inc.
Post Office Box 27353
Las Vegas, Nevada 89126
1-800-800-5565
Foreign call 805-822-9655
(Mastercard, VISA, Discover)

SHIPPING CHARGES:

USA (except Alaska & Hawaii)
UPS-\$3.75 1st title, \$1.00 ea add'l
Bookrate-\$2.50 1st title, \$1.00 ea add'l
Priority-\$3.40 1st title, \$1.00 ea add'l

ALASKA & HAWAII
Bookrate-\$2.50 1st title, \$1.00 ea add'l
Priority-\$3.40 1st title, \$1.00 ea add'l
UPS 2nd day-\$9.00 1st title, \$1 ea add'l

CANADA & MEXICO
Surface-\$3.00 1st title, \$1.50 ea add'l
Airbook-\$4.50 1st title, \$2.00 ea add'l

FOREIGN
Surface-\$3.00 1st title, \$1.50 ea add'l
Airbook-\$8.00 per title estimate
(Please allow 5-8 weeks for delivery)

CONTACT: THE PHOENIX PROJECT Subscription Rates

CONTACT: THE PHOENIX PROJECT
is published by

CONTACT, Inc.

Post Office Box 27800

Las Vegas, Nevada 89126

Subscription orders may be placed by mail to the above address or by phone to 1-800-800-5565. Subscription rates are: \$20 for 13 issues (US); \$22 (Canada/Mexico); \$30 (Foreign); or 26 issues for \$40 (US); \$44 (Canada/Mexico); \$60 (Foreign); or 52 issues for \$75 (US); \$80 (Canada/Mexico); \$110 (Foreign). **Subscribers: Expiration date appears on right side of mailing label.** **Quantity Subscriptions:** \$97.50 for 25 copies of 13 issues; \$135. for 50 copies of 13 issues (US); \$250 for 100 copies of 13 issues (US); \$500 for 100 copies of 26 issues (US); or \$1,000 for 100 copies of 52 issues (US). UPS postpaid Continental U.S. For Alaska, HI, Canada, Mexico and Foreign, call or write for shipping charges. Single copies of back issues of **CONTACT, THE PHOENIX LIBERATOR** or **PHOENIX EXPRESS** are \$1.50 each. Quantity back issue prices are as follows: 1-10 copies \$1.50 each; 11-50 copies \$15.00; 51-100 copies \$25.00. Shipping included, postpaid in the Continental U.S.A. Alaska, Hawaii, Canada & Foreign orders please call or write for quotes on additional shipping charges.

Copyright Statement

COPYRIGHT 1993 by **CONTACT, Inc.** Reproduction of this newspaper for private, non-profit use is expressly encouraged, as long as the content and integrity remain absolutely unchanged. For commercial purposes, reproduction is strictly forbidden unless and until permission is granted in writing by **CONTACT, INC.**

*The Best Gift
You Can Give Is*

**THE
TRUTH**

*Subscribe to
CONTACT
and read
The JOURNALS*